

User manual

Solar Grid-tied Inverter

Product Model: SOFAR 3.3~12KTLX-G3



Contents

Preface.....	II
1. Basic Safety Information.....	- 1 -
1.1. Requirement for Installation and Maintenance.....	- 1 -
1.2. Symbols and signs.....	- 4 -
2. Product Characteristics.....	- 7 -
2.1. Intended Use.....	- 7 -
2.2. Function Description.....	- 11 -
2.3. Electrical block diagram.....	- 12 -
2.4. Efficiency and derating curve.....	- 12 -
3. Installation.....	- 14 -
3.1. Installation Process.....	- 14 -
3.2. Checking Before Installation.....	- 14 -
3.3. Tools.....	- 17 -
3.4. Determining the Installation Position.....	- 19 -
3.5. Moving of inverter.....	- 20 -
3.6. Installation.....	- 21 -
4. Electrical Connection.....	- 23 -
4.1. Electrical Connection.....	- 24 -
4.2. Grounding Connection (PE).....	- 24 -
4.3. AC-Output Wiring.....	- 26 -
4.4. Connect PV side of inverter (DC-Input).....	- 29 -
4.5. Communication Connection.....	- 32 -
5. Commissioning of inverter.....	- 42 -
5.1. Cable Connection Inspection.....	- 42 -
5.2. Start Inverter.....	- 42 -
5.3. Shutdown inverter.....	- 43 -
5.4. Setting power quality response modes.....	- 43 -
6. Operation interface.....	- 44 -
6.1. Operation and Display Panel.....	- 44 -
6.2. Standard Interface.....	- 45 -
6.3. Main Interface.....	- 47 -
6.4. Updating Inverter Software.....	- 55 -
7. Trouble shooting and maintenance.....	- 58 -
7.1. Troubleshooting.....	- 58 -
7.2. Maintenance.....	- 67 -
8. Technical Data.....	- 68 -
9. Quality Assurance.....	- 74 -

Preface

Notice

Thank you on your purchase of a SofarSolar inverter. This manual contains important safety and operational information that assist you in using this product. Please observe all applicable safety regulations that have been mandated by your local electrical supplier.

Save these instructions!

This manual should be considered a piece of safety equipment and therefore must accompany the device, even when it is transferred to another user or site.

Copyright Declaration

The copyright of this manual belongs to Shenzhen SOFARSOLAR Co. Ltd. Any corporation or individual should not plagiarise, partially copy or fully copy it (including software, etc), and no reproduction or distribution of it in any form or by any means. All right reserved.

SOFARSOLAR reserves the right of final interpretation. This manual is subject to change according to user's or customer's feedback. Please check our website at <http://www.sofarsolar.com> for latest version.

The current Version updated at 20211206.

The current Version is V1.01-AU.

Shenzhen SOFARSOLAR Co., Ltd

Location: 401, Building 4, Antongda Industrial Park, District 68, XingDong Community, XinAn Street, BaoAn District, Shenzhen, China.

Postcode: 518000

Company Website: www.sofarsolar.com

Email: service@sofarsolar.com

Outline

This manual is an integral part of SOFAR 3.3~12KTLX-G3. It describes the assembly, installation, commissioning, maintenance and troubleshooting of the product. Please read it carefully before operating.

Scope of Validity

This manual contains important instructions for:





SOFAR 3.3KTLX-G3	SOFAR 4.4KTLX-G3	SOFAR 5KTLX-G3-A
SOFAR 5.5KTLX-G3	SOFAR 6.6KTLX-G3	SOFAR 8.8KTLX-G3
SOFAR 8.8KTLX-G3-A	SOFAR10KTLX-G3-A	SOFAR 11KTLX-G3
SOFAR 11KTLX-G3-A	SOFAR 12KTLX-G3	

Target Audience

This manual is for qualified electricians. The tasks described in this manual only can be performed by qualified electricians.

Symbols Used

The following types of safety instruction and general information appear in this document as described below:

 Danger	<p>“Danger”indicates a hazardous situation which, if not avoided, will result in death or serious injury.</p>
 Warning	<p>“Warning”indicates a hazardous situation which, if not avoided, could result in death or serious injury</p>
 Caution	<p>“Caution”indicates a hazardous situation which, if not avoided, could result in minor or moderate injury</p>
 Attention	<p>“Attention”indicates there are potential risks, if fail to prevent, may lead to equipment cannot normally or property damage.</p>
 Note	<p>“Note”provides additional information and tips that are valuable for the optimal operation of the product.</p>

1. Basic Safety Information

Outline of this Chapter

Please read the instruction carefully. Faulty operation may cause serious injury or death.

	<p>If you have any question or problem when you read the following information, please contact Shenzhen SOFARSOLAR CO., Ltd.</p>
<p>Note</p>	

Safety Instruction

Introduce the safety instruction during installation and operation of SOFAR 3.3~12KTLX-G3.

Symbols Instruction

This section gives an explanation of all the symbols shown on the inverter and on the type label.

1.1. Requirement for Installation and Maintenance

Installation of SOFAR 3.3~12KTLX-G3 on-grid inverter must conform with laws, regulations, codes and standards applicable in the jurisdiction.

Before installing and adjusting the produce, please read all of instructions, cautions and warnings in this manual.

Before connecting the product to the electrical utility grid, contact the local utility company for allowance. Also, this connection must be made only by qualified electrician.

If the failure persists, please contact the nearest authorized maintenance centre.

If you don't know which service centre is closest to you, please contact your local distributor. Don't attempt to repair the product by yourself, this may lead serious injury or damage.

Qualified Person

When inverter is working, it contains lethal voltages and went hot in some area. Improper installation or maloperation could cause serial damage and injury. To reduce the risk of personal injury and to ensure the safe installation and operation of the product, only a qualified electrician is allowed to execute transportation, installation, commissioning and maintenance. Shenzhen SOFARSOLAR Co, Ltd does not take any responsibility for the property destruction and personal injury because of any incorrect use.

Label and Symbols

SOFAR 3.3~12KTLX-G3 has a labels and warning symbols attach the side of product which contains important information and technical data, these labels must not be removed from the device.

Installation location requirement

Please install inverter on surfaces with enough load bearing capacity (such as walls, PV racks etc.). Ensure adequate clearance around and in particularly above the unit is left for passive/active ventilation. Ensure the inverter is installed in a wall ventilated environment and have enough air-cooling cycle. Air humidity should less than 90%.

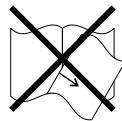
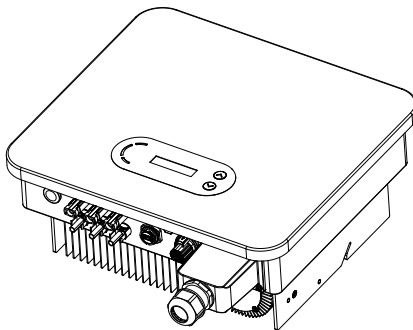

Transportation Requirement



If you find packing problems that may have caused damage of the inverter, or find any visible damage, please notify the transportation company immediately.

The factory packaging is designed to prevent transportation related damage i.e. violent shocks, humidity, vibration, however if the unit is visibly damaged, do



not install it.

Electrical Connection



Please comply with all the current electrical regulations about accident prevention in dealing with the current inverter.

 Danger	<p>Before the electrical connection, use opaque material to cover the PV modules or disconnect PV string DC switch. PV arrays will produce dangerous voltage if it is exposure under sun.</p>
 Warning	<p>All operation must accomplish by certified electrical engineer</p> <ul style="list-style-type: none"> ● Must be trained; ● Completely read the manual operation and understand all information.
 Attention	<p>Must get permission by local utility company before connecting to grid and the connection must be done by certified electricians.</p>

Operation

 Danger	<p>Touching the utility grid or the terminal conductors can lead to lethal electric shock or fire!</p> <p>Do not touch non-insulated cable ends, DC conductors and any live components of the inverter.</p> <p>Attention to any electrical relevant instruction and document.</p>
 Attention	<p>Enclosure or internal components may get hot during operation. Do not touch hot surface or wear insulated gloves.</p> <p>Keep it away from kids!</p>

Maintenance and repair

 Danger	<p>Before any repair work, turn OFF the AC circuit breaker between the inverter and electrical grid first, then turn OFF the DC switch.</p> <p>After turning OFF the AC circuit breaker and DC switch wait for at least 5 minutes before carry any maintenance or repair work.</p>
	<p>Inverter should not work again until removing all faults. If any repair work is required, please contact local authorized service centre.</p>

Attention	Should not open the inverter cover without authorized permit, SOFARSOLAR does not take any responsibility for that.
------------------	---





EMC/Noise Level

Electromagnetic compatibility (EMC) refers to that on electrical equipment functions in a given electromagnetic environment without any trouble or error, and impose no unacceptable effect upon the environment. Therefore, EMC represents the quality characters of an electrical equipment.

- The inherent noise-immune character: immunity to internal electrical noise
- External noise immunity: immunity to electromagnetic noise of external system
- Noise emission level: influence of electromagnetic emission upon environment







	Electromagnetic radiation from inverter may be harmful to health! Please do not continue. Stay away from the inverter in no less than 20cm when inverter is operational.
Danger	



1.2. Symbols and signs

	High voltage of inverter may be harmful to health! Only certified engineer can operate the product; Juveniles, Disable, should not use this product; Keep this product out of the reach of children;
Danger	
	Caution of burn injuries due to hot enclosure! Only touch the screen and pressing key of the inverter while it is working.
Caution	
	PV array should be grounded in accordance to the requirements of the local electrical grid company.
Attention	
	Ensure input DC voltage < Max. DC voltage .Overvoltage may cause permanent damage to inverter or other losses, which will not be included in warranty!
Warning	

Warning signs on the device

SOFAR 3.3~12KTLX-G3 has some safety symbols on the inverter. Please read and fully understand the meaning of the symbols before installation.

Symbols	Name	Explanation
	This is a residual voltage in the inverter!	After disconnect with the DC side, there is a residual voltage in the inverter, operator should wait for 5 minutes to ensure the capacitor is completely discharged.
	Caution of high voltage and electric shock	The products operates at high voltages. Prior to performing any work on the product, disconnect the product from voltage sources. All work on the product must be carried out by qualified persons only.
	Caution of hot surface	The product can get hot during operation. Avoid contact during operation. Prior to performing any work on the product, allow the product to cool down sufficiently
	The product complies with the CE Certification	
	Grounding Terminal	This symbol indicates the position for the connections of an additional equipment grounding conductor
	Observe the documentation	Read all documentation supplied with the product before install
	Positive pole and negative pole	Positive pole and negative pole of the input voltage (DC)

	Temperature	Indicated the temperature allowance range
	RCM logo	RCM (Regulatory Compliance Mark) The product complies with the requirements of the applicable Australian standards.

2. Product Characteristics

Outline of this Chapter

Product Dimensions

Introduce the field of use and the dimensions of the product

Function Description

Introduce working principle and internal components of the product

Efficiency Curves

Introduce the efficiency curves of the product

2.1. Intended Use

Field of use

SOFAR 3.3~12KTLX-G3 is a transformer-less on grid PV inverter, that converts the direct current of the PV panels to the grid-compliant, three-phase current and feeds into the utility grid.

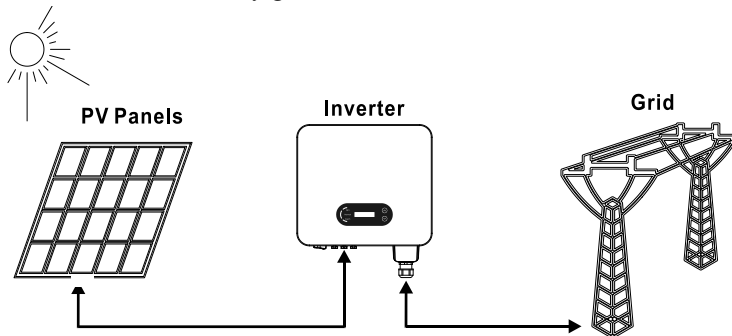

Figure 2- 1 PV Grid-Tied System

SOFAR 3.3~12KTLX-G3 may only be operated with PV arrays (photovoltaic module and cabling) for on grid condition. Do not use this product for any other or additional purposes. Any damage or property loss due to any use of the product other than described in this section, SOFARSOLAR will not take the responsibility. DC input of the product must be PV module, other source such

like DC sources, batteries will void the manufacturers warranty.

Intended grid types

SOFAR 3.3~12KTLX-G3 configurations. For the TT type of electricity grid, the voltage between neutral and earth should be less than 30V. inverters are compatible with TN-S, TN-C, TN-C-S, TT, IT grid.

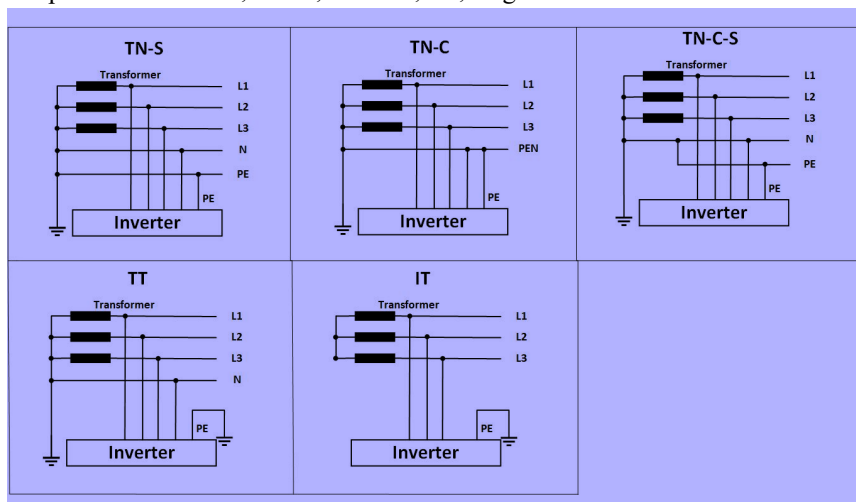

Figure 2-2 Overview of grid configurations

Product Dimensions

The choice of optional parts of inverter should be made by a qualified technician who knows the installation conditions clearly.

Dimensions Description

SOFAR 3.3KTLX-G3

SOFAR 4.4KTLX-G3

SOFAR 5KTLX-G3-A

SOFAR 5.5KTLX-G3

SOFAR 6.6KTLX-G3

SOFAR 8.8KTLX-G3

SOFAR 8.8KTLX-G3-A

SOFAR10KTLX-G3-A

SOFAR 11KTLX-G3

SOFAR 11KTLX-G3-A

SOFAR 12KTLX-G3

L×W×H=430*385*182mm

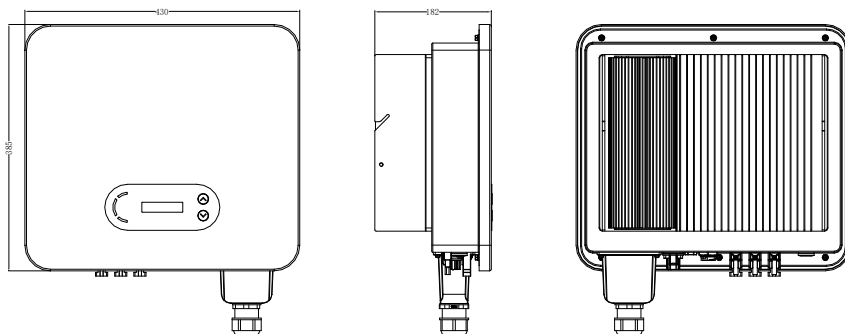

Figure 2-3 Front, side and back of the machine (3.3~12K)

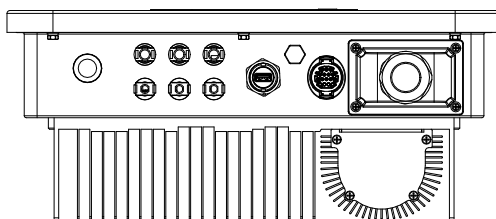

Figure 2-4 Bottom view

Note: 3.3KTLX-G3 ,4.4KTLX-G3, 5KTLX-G3-A, 5.5KTLX-G3,6.6KTLX-G3,8.8KTLX-G3, 11KTLX-G3 supports 2-channel PV string input; 8.8KTLX-G3-A, 10KTLX-G3-A, 11KTLX-G3-A, 12KTLX-G3 supports 3-channel PV string input.

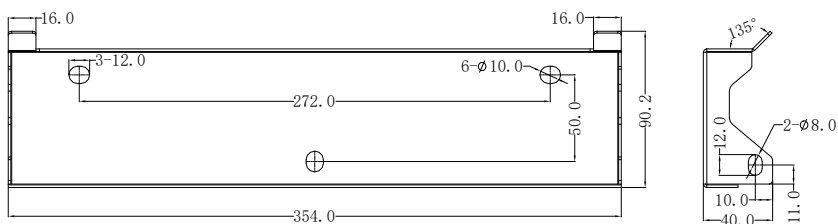

Figure 2-5 Mounting bracket dimensions

Function description of inverter box (bottom)

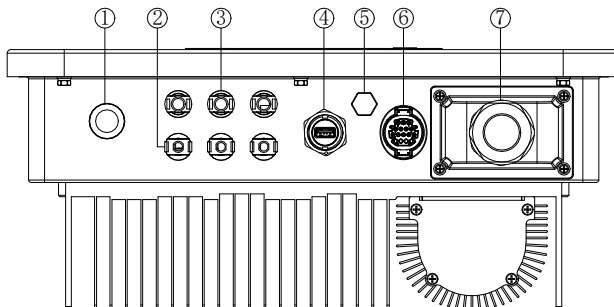

Figure 2- 6 Bottom view of the SOFAR 3.3~12KTLX-G3

1. DC switch plug assembly, additional DC switches need to be installed
2. DC negative connectors
3. DC positive connectors
4. USB Port (for WIFI or Ethernet communication)
5. Breather valve
6. COM Port (for RS485 communication)
7. AC output

Label on the equipment

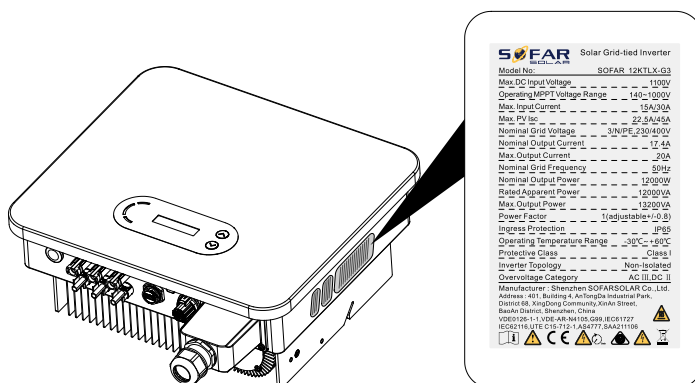

Figure 2- 7 Product label

Note: label must NOT be hidden with objects and extraneous parts (rags, boxes, equipment, etc.); they must be cleaned regularly and kept visible at all times.

2.2. Function Description

DC power generated by PV arrays is filtered through Input Board then enter Power Board. Input Board also offer functions such as insulation impedance detection and input DC voltage/ current detection. DC power is converted to AC power by Power Board. AC power is filtered through Output Board then AC power is fed into the grid. Output Board also offer functions such as grid voltage/ output current detection, GFCI and output isolation relay. Control Board provides the auxiliary power, controls the operation state of inverter and shows the operation status by Display Board. Display Board displays fault code when inverter is abnormal operation conditions. At the same time, Control Board can trigger the replay to protect the internal components.

Function Module

A. Energy management unit

Remote control to start/down inverter through an external control.

B. Feeding reactive power into the grid

The inverter is able to produce reactive power thus to feed it into the grid through the setting of the phase shift factor. Feed-in management can be controlled directly by APP or through a RS485 interface.

C. Limited the active power fed into grid

If enable the limited of active power function, inverter can limit the amount of active power fed into the grid to the desired value (expressed as percentage).

D. Self-power reduction when grid is over frequency

If grid frequency is higher than the limited value, inverter will reduce the output power to ensure the grid stability.

E. Data transmission

Inverter or a group of inverters can be monitored remotely through an advanced communication system based on RS485 interface or via USB port.

F. Software update

USB interface for uploading the firmware, remotely uploading by using USB acquisition stick (WIFI or Ethernet) is also available.

2.3. Electrical block diagram

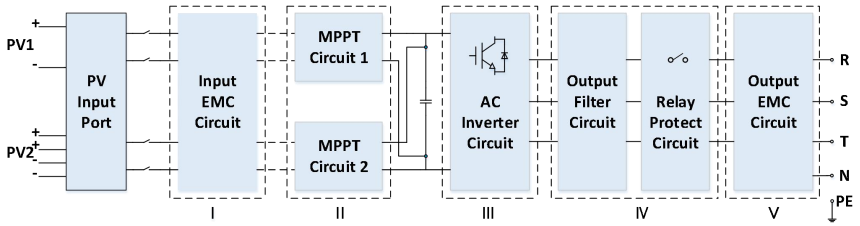

Figure 2-8 Electrical block diagram

2.4. Efficiency and derating curve

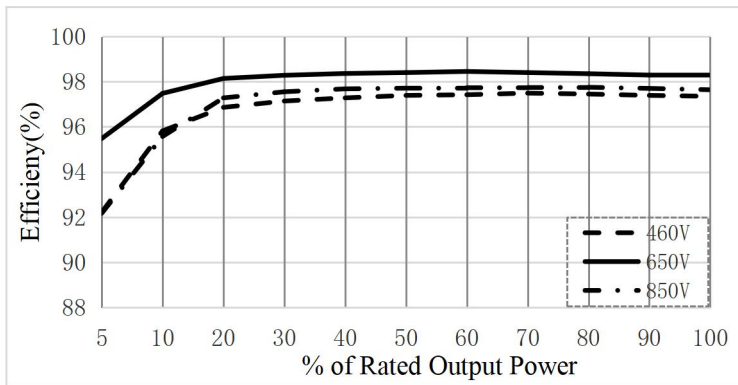

Figure 2-9 Typical efficiency curve (of the 12KW)

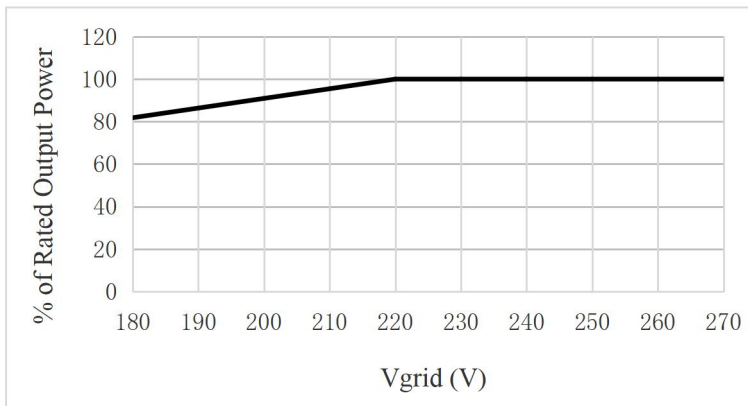





Figure 2- 10 Rated Power ratio vs Grid Voltage

3. Installation

Outline of this Chapter

This topic describes how to install this product, please read carefully before install.

 Dangers	Do NOT install the product on flammable material. Do NOT store this product in potentially explosive atmospheres.
 Caution	The enclosure and heat sink will get hot during operation, please do not mount the product at a easy to reach location.
 Attention	Consider the weight of this product when doing transport and moving. Choose an appropriate mounting position and surface. At least two persons for installation.

3.1. Installation Process

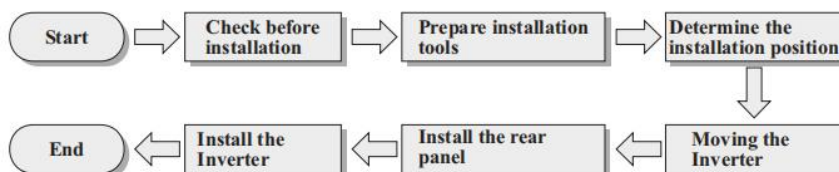



3.2. Checking Before Installation





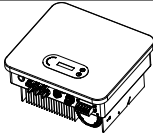
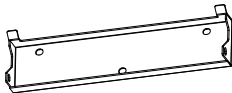
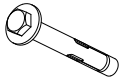
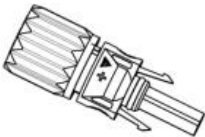

Checking Outer Packing Materials

Before unpacking, please check the condition of the outer package materials if any damaged found, such as holes, cracks, please not unpack the product, contact your distributor immediately. Recommend installing the product within 24 hours after unpacking the package.

Checking Contents

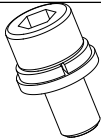
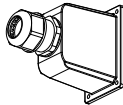
After unpacking, please check according to following table, to see whether all the parts were included in the packing, please contact your distributor immediately if anything missing or damage.

No	Pictures	Description	Quantity
1		SOFAR 3.3~12KTLX-G3	1 PCS
2		Rear Panel	1 PCS
3		M6*80 Hexagon screws	3 PCS
4		PV+ input connector	8.8KTLX-G3-A 3 PCS 10KTLX-G3-A 3 PCS 11KTLX-G3-A 3 PCS 12KTLX-G3 3 PCS 3.3KTLX-G3 2 PCS 4.4KTLX-G3 2 PCS 5KTLX-G3-A 2 PCS 5.5KTLX-G3 2 PCS 6.6KTLX-G3 2 PCS 8.8KTLX-G3 2 PCS 11KTLX-G3 2 PCS
5		PV- input connector	8.8KTLX-G3-A 3 PCS 10KTLX-G3-A 3 PCS 11KTLX-G3-A 3 PCS 12KTLX-G3 3 PCS 3.3KTLX-G3 2 PCS 4.4KTLX-G3 2 PCS 5KTLX-G3-A 2 PCS 5.5KTLX-G3 2 PCS 6.6KTLX-G3 2 PCS 8.8KTLX-G3 2 PCS 11KTLX-G3 2 PCS

6		PV+ metal pin	8.8KTLX-G3-A 3 PCS 10KTLX-G3-A 3 PCS 11KTLX-G3-A 3 PCS 12KTLX-G3 3 PCS 3.3KTLX-G3 2 PCS 4.4KTLX-G3 2 PCS 5KTLX-G3-A 2 PCS 5.5KTLX-G3 2 PCS 6.6KTLX-G3 2 PCS 8.8KTLX-G3 2 PCS 11KTLX-G3 2 PCS
7		PV- metal pin	8.8KTLX-G3-A 3 PCS 10KTLX-G3-A 3 PCS 11KTLX-G3-A 3 PCS 12KTLX-G3 3 PCS 3.3KTLX-G3 2 PCS 4.4KTLX-G3 2 PCS 5KTLX-G3-A 2 PCS 5.5KTLX-G3 2 PCS 6.6KTLX-G3 2 PCS 8.8KTLX-G3 2 PCS 11KTLX-G3 2 PCS
8		M6*12 Hexagon screws	3 PCS
9		AC waterproof cover	1 PCS
10		M4*12 cross screw (For locking the waterproof cover)	4 PCS
11		Manual	1PCS
12		Warranty Card	1PCS





13		Quality Certificate	1PCS
14		R-type terminal	5PCS
15		Communication Terminal	1PCS
16		USB logger (WIFI/GPRS/Ethernet)	1 PCS (Optional)

Table 3- 1 Package contents

3.3. Tools

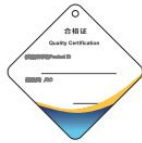
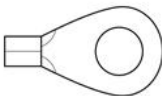
Prepare tools required for installation and electrical connection as following table:

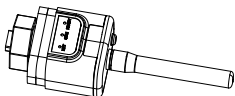
No	Tool	Description	Function
1		Hammer Drill Recommend drill @ 80mm	Used to drill holes on the wall
2		Screwdriver	Use to tighten and loosen screws when installing AC power cable Use to remove AC connectors from the product
3		Removal Tool	Remove PV Connector

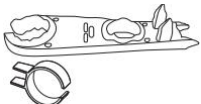





4		Wire Stripper	Used to peel cable
5		M6 hexagon wrench	M6 use to uninstall and install the front top cover and down cover
6		Crimping Tool	Use to crimp cable on grid side, load side and CT extensive cable
7		Multimeter	Check grounding cable, PV positive and negative pole
8		Marker	Mark signs
9		Measuring Tape	Measure distance
10		Level	Ensure the rear panel is properly installed
11		ESD gloves	Installer wear when installing product
12		Safety goggles	Installer wear when installing product
13		Mask	Installer wear when installing product

Table 3-2 Installation tools

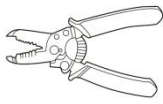
3.4. Determining the Installation Position

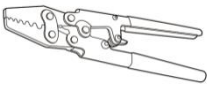
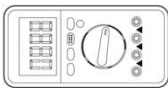
This unit is designed to be wall mounted,. When selecting an appropriate location for the inverter, observe the following:

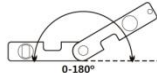
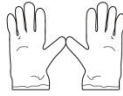
Installed vertically (to within 15° skew) with the AC plug facing downwards

Away from direct sunlight throughout the whole year

Away from areas where debris can collect on top of the unit and block its ability to cool.

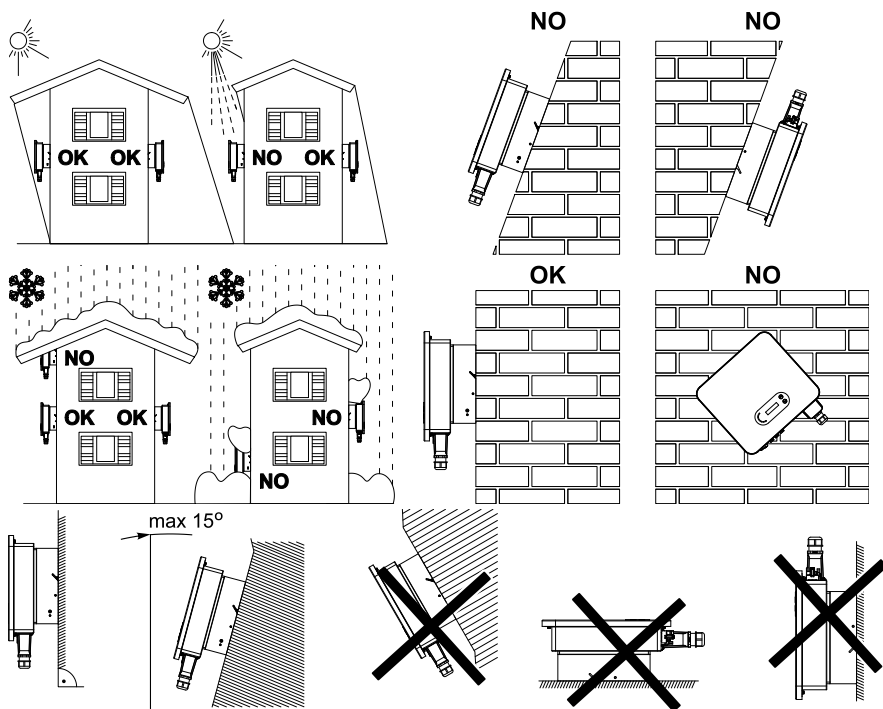

Figure 3-2 Installation position selection

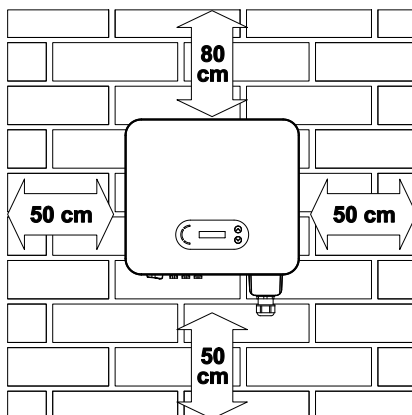

Figure 3-3 Wall clearances for single inverter

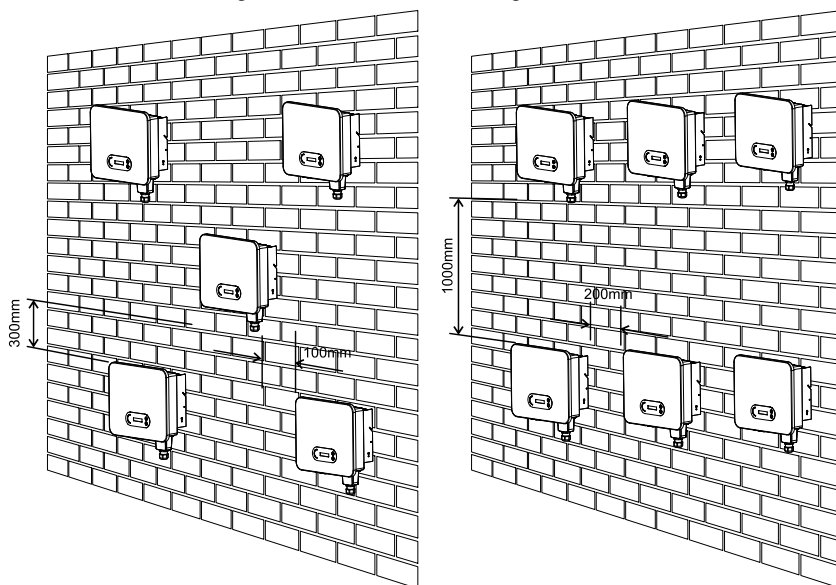

Figure 3-4 Wall clearances for multiple inverters

3.5. Transporting the inverter

Unload the inverter from package, horizontally move to the install position. When opening the package, carefully lift the inverter with hands from the back of heat sink part. At least two operators to lift the inverter up.

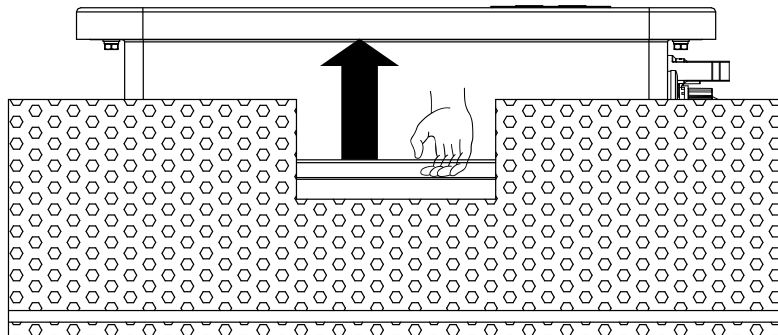

Figure 3-5 Remove inverter from package (1)

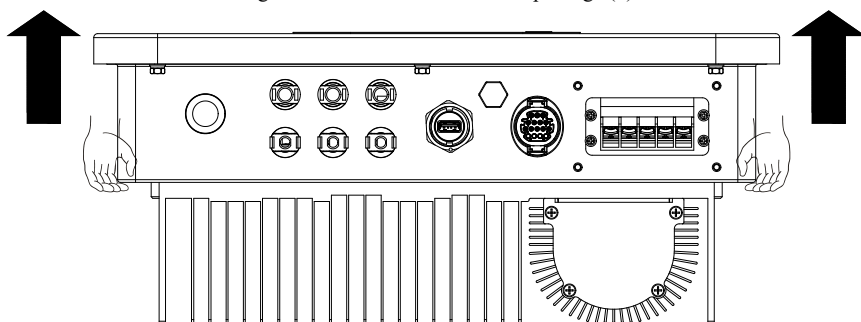

Figure 3-6 Remove inverter from package (2)

Attention

Inverter is heavy, attention to keep the balance when lift the inverter. Dropped while being transported may cause injuries.

Do not put the inverter with wiring terminals contacting the floor because the power ports and signal ports are not designed to support the weight of the inverter

When placing the inverter on the floor, put it above foam or paper to avoid the damage of the casing of the inverter.

3.6. Installation

Step 1: Place the rear panel on the mounting wall, determine the mounting height of the bracket and mark the mounting poles accordingly. Drilling holes by using Hammer Drill, keep the hammer drill perpendicular to the wall and make sure the position of the holes should be suitable for the expansion bolts.

Step 2: Align the rear panel with the hole position, and drive the M6 expansion

bolt in.

Step 3: Fix the rear panels on the wall by tightening the M6*80 Hexagon screws

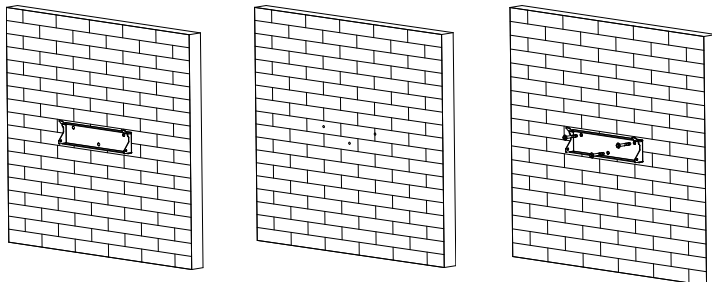

Figure 3-7 Installation instruction (1)

Step 4: Lift the inverter and hang it on the rear panel, and fixing both sides of inverter with the supplied M6 screw.

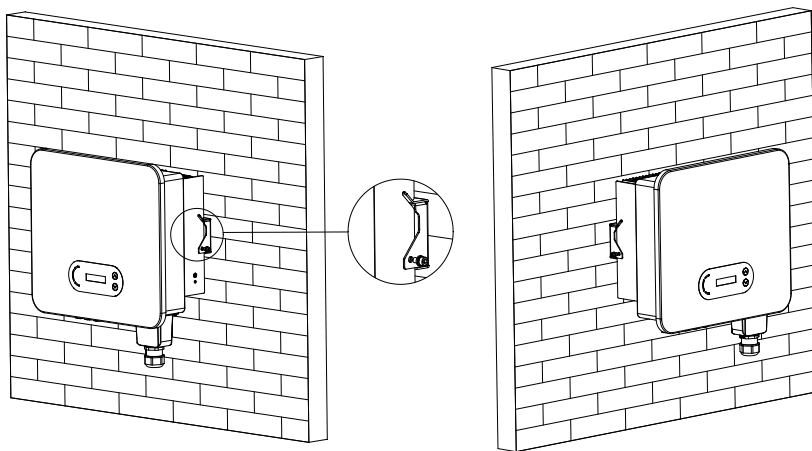

Figure 3-8 Installation instruction (2)



4. Electrical Connection

Outline of this Chapter

This section introduces the electrical connection for the product. Please read the information carefully, it will be helpful to understand the grounding, DC input, AC output and communication connections and requirements.

Caution:

Before performing any electrical connections, ensure the DC switch is OFF and AC circuit breaker is OFF. Allow up to 5 minutes for the capacitor to be discharged.

	Installation and maintenance should be done by certified electrical engineer
Attention	
	Before the electrical connection, use opaque material to cover the PV modules or disconnect PV string DC switch. PV arrays will produce dangerous voltage if it is exposure under sun
Danger	
	For this product, the open circuit voltage of PV strings should not greater 1100V
Note	

The connected panel must meet the standard IEC61730A.

String Model	Isc PV(maximum)	Maximum output current (A)
SOFAR 3.3KTLX-G3	22.5A/22.5A	5A
SOFAR4.4KTLX-G3	22.5A/22.5A	6.7A
SOFAR 5KTLX-G3-A	22.5A/22.5A	7.6A
SOFAR5.5KTLX-G3	22.5A/22.5A	8.3A
SOFAR 6.6KTLX-G3	22.5A/22.5A	10A
SOFAR 8.8KTLX-G3	22.5A/22.5A	13.3A

SOFAR 8.8KTLX-G3-A	22.5A/45A	13.3A
SOFAR 10KTLX-G3-A	22.5A/45A	15.2A
SOFAR 11KTLX-G3	22.5A/22.5A	16.7A
SOFAR 11KTLX-G3-A	22.5A/45A	16.7A
SOFAR 12KTLX-G3	22.5A/45A	20A

Note: In the above table, the first value of I_{sc} PV is for MPPT 1, the second value of I_{sc} PV is for MPPT 2.

NOTE: The DVC is the voltage of a circuit which occurs continuously between any two live part in the worst-case rated operating condition when used as intended.

Interface	DVC
PV input interface	DVCC
AC output interface	DVCC
USB interface	DVCA
COM interface	DVCA
WiFi/GPRS/Ethernet interface	DVCA

Table 4- 1 The decisive voltage class (DVC) of terminals

4.1. Electrical Connection

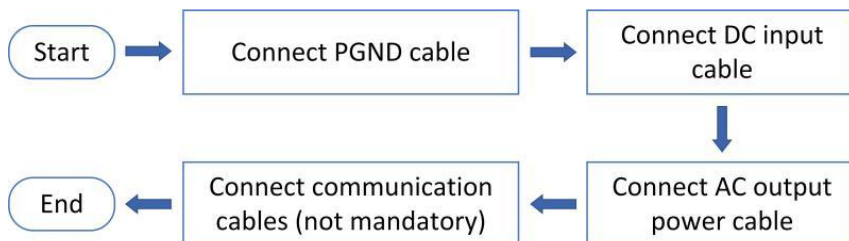



Figure 4- 1 Flowchart for connecting cables to the inverter

4.2. Grounding Connection (PE)

Connect the inverter to the grounding electrode using ground cable

	<p>SOFAR 3.3~12KTLX-G3 is a transformerless inverter which requires the positive pole and negative pole of the PV array to be floating with respect to PE. Otherwise, it will cause inverter failure. In the PV system, all non-current-carrying metal parts (such as mounting frame, combiner box enclosure, etc.) should be connected to earth.</p>
<p>Note</p>	

We recommend the earthing cable to be 2.5mm² or greater and to be

coloured yellow-green.

Procedure:

Step 1: Remove the insulation layer with an appropriate length using a wire stripper shown as figure 4-2)

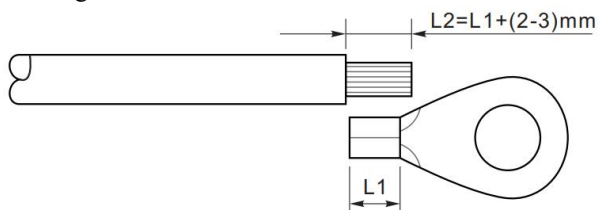

Figure 4-2 Grounding connection instruction (1)

Note: the length of L2 should 2~3mm higher than L1

Step 2: Insert the exposed core wires into the OT terminal and crimp them by using a crimping tool, as shown as figure 5.3. Recommend using OT terminal: OT-M6, Cable: $\geq 6\text{mm}^2$

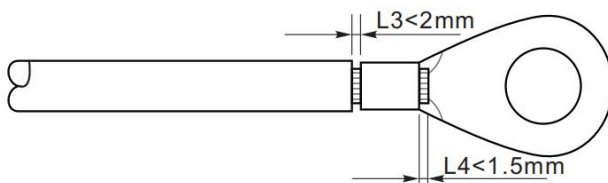
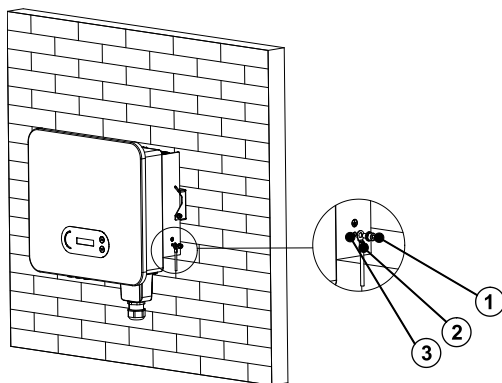

Figure 4-3 Grounding connection instruction (2)

Note 1: L3 is the length between the insulation layer of the ground cable and crimped part. L4 is the distance between the crimped part and core wires protruding from the crimped part.

Note 2: The cavity formed after crimping the conductor crimp strip shall wrap the core wires completely. The core wires shall contact the terminal closely.

Step 3: Tighten the OT terminal by using M6 screw. Recommend torque is 5N.m



1. M6 Screw 2. OT Terminal 3. Threaded Hole

Figure 4-4 Inverter external grounding instruction diagram

4.3. AC-Output Wiring

SOFAR 3.3~12KTLX-G3 connect to utility grid by using AC power cable. The AC connection must meet the requirement of local grid operator

 Caution	<p>Ban multiple Inverters use one circuit breaker Ban connect loads between inverter and circuit breaker</p>
---	---

Must use five core outdoor cable, the recommend AC cable and Residual Current Device (RCD) as below table:

Model	Cross section area of Cu cable (mm ²)	Muti-core outdoor cable (mm)	AC Circuit Breaker specification (Type B)
SOFAR 3.3KTLX-G3	2~3, recommend 2.5	18~25	16A/230V/3P current leakage protection 0.1A
SOFAR 4.4KTLX-G3	2~3, recommend 2.5	18~25	16A/230V/3P current leakage protection 0.1A
SOFAR 5KTLX-G3-A	3~4, recommend 3	18~25	16A/230V/3P current leakage protection 0.1A
SOFAR 5.5KTLX-G3	3~4, recommend 3	18~25	16A/230V/3P current leakage protection 0.1A
SOFAR 6.6KTLX-G3	3~4, recommend 4	18~25	20A/230V/3P current leakage protection 0.1A
SOFAR 8.8KTLX-G3-A	4~6, recommend 5	18~25	25A/230V/3P current leakage protection 0.1A

SOFAR 8.8KTLX-G3	4~6, recommend 5	18~25	25A/230V/3P current leakage protection 0.1A
SOFAR 10KTLX-G3-A	4~6, recommend 5	18~25	25A/230V/3P current leakage protection 0.1A
SOFAR 11KTLX-G3-A	5~7, recommend 6	18~25	32A/230V/3P current leakage protection 0.1A
SOFAR 11KTLX-G3	5~7, recommend 6	18~25	32A/230V/3P current leakage protection 0.1A
SOFAR 12KTLX-G3	5~7, recommend 6	18~25	32A/230V/3P current leakage protection 0.1A

Table 4-2 AC breaker and RCD specifications

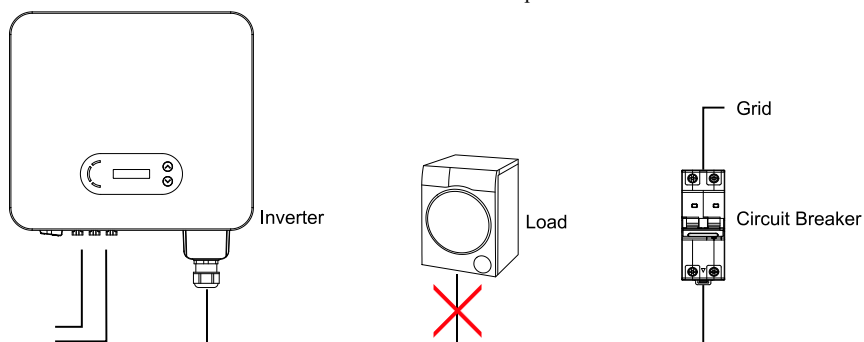

Figure 4-5 Incorrect connection between load and inverter

The resistance at connection point must less than 2Ω . In case to have a properly anti-islanding function, please choose the high-quality PV cable and ensure the power loss is less than 1%. Meanwhile, the inverter AC side to grid connection point must less than 100m. the relation between cable length, cross section area and power loss as below:

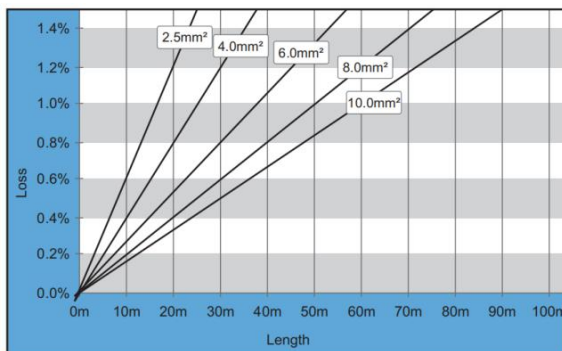

Figure 4-6 AC side CSA vs power loss

The AC output terminal of this product is equipped with high current 5-core terminal block and customised AC output waterproof cover, which can meet the IP65 level requirements for installation.

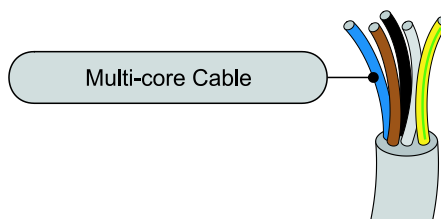
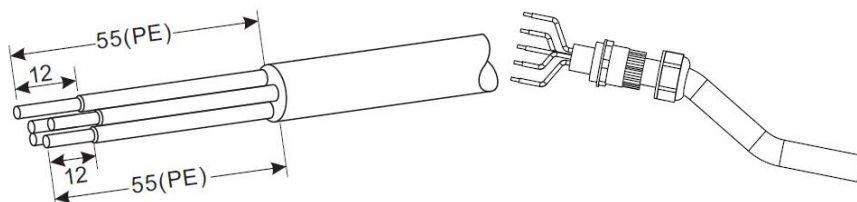

Figure 4-7 A 3 phase cable

Wiring Procedure as following:

Step 1: Select the appropriate cable diameter according to table 4-1, process the cable according to the following picture size requirements, and then pass-through PG waterproof joint;



R type terminal,

Insulating sleeve,

RNBL5-4 (10-12awg).

terminal shall not be exposed.



Figure 4-8 AC cable connection instruction diagram (1)

Step 2: After assembling the PG waterproof connector, connect the cable to the AC terminal block L1, L2, L3, N, PE contacts, and fasten them (1~1.6 N · m). Tighten the lock nut of PG terminal clockwise (5~5.5 N · m).

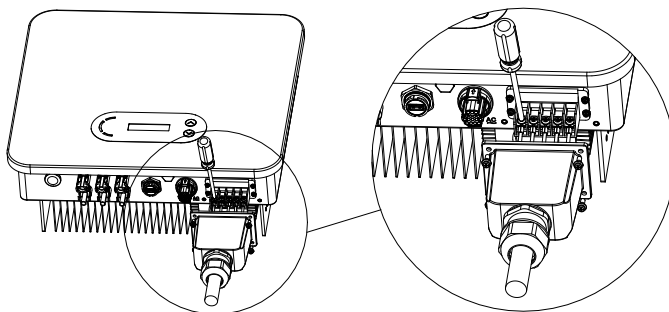

Figure 4-9 AC cable connection instruction diagram (2)

4.4. Connect PV side of inverter (DC-Input)

Table 4-2 Recommend DC input cable size (maximum tolerance voltage \geq 1100V PV cable)

Copper cable cross section area (mm ²)	Cable OD (mm)
4~6.0	6.0~9.0

Step 1: Find the metal contact pins in the accessories bag, connect the cable according to below diagram (1.Positive cable, 2. negative cable);

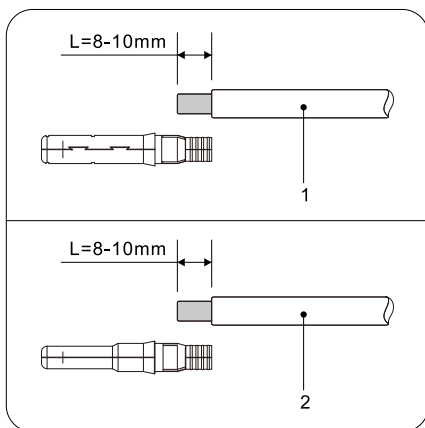

Figure 4- 10 DC cable connection (1)

Step 2: Crimp the PV metal contact pin to the striped cable using a proper crimping pliers;

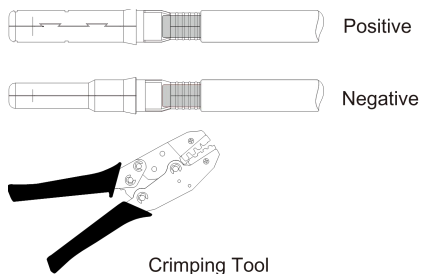

Figure 4- 11DC cable connection (2)

Step 3: Insert wire into the connector cap nut and assemble into the back of male or female plug, When you heard a “click”, the pin tact assembly is seated correctly. (3. Positive Connector, 4. negative connector);

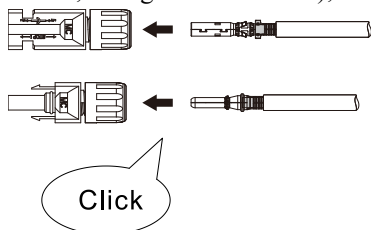

Figure 4- 12 DC cable connection (3)

Step 4: Measure PV voltage of DC input with multimeter, verify DC input cable polar and connect DC connector with inverter until hearing a slight sound indicated connection succeed.

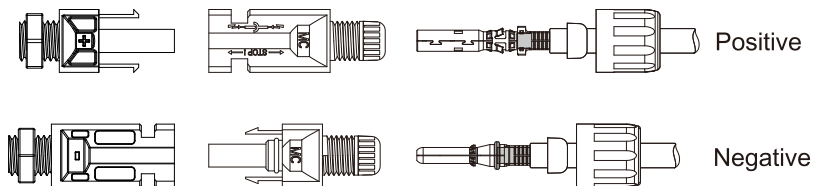

Figure 4-13 DC cable connection(4)

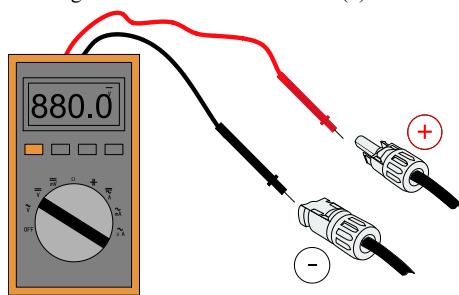



Figure 4-14 Use a multimeter to check the positive and negative electrodes

Note: Please use a multimeter to make sure the PV array positive pole and negative pole!

If need to remove the PV connector from inverter side, please use the Removal Tool as below diagram, move the connector gently.

 NOTE	<p>Before, moving the positive and negative connector, please make sure “DC Switch” is on OFF position.</p>
---	---

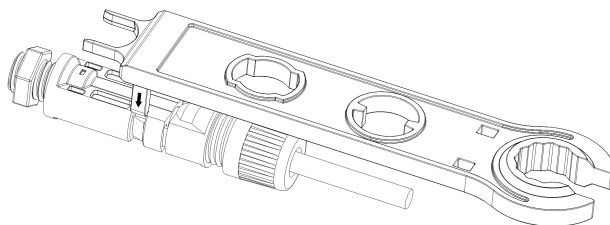



Figure 4-15 Removal DC connector

4.5. Communication Connection

 Note	<p>When layout the wiring diagram, please separate the communication wiring and power wiring in case the signal be affected.</p>
--	--

3.3~12KTLX-G3 inverter has one USB Port and one COM Port, as shown in the following figure.

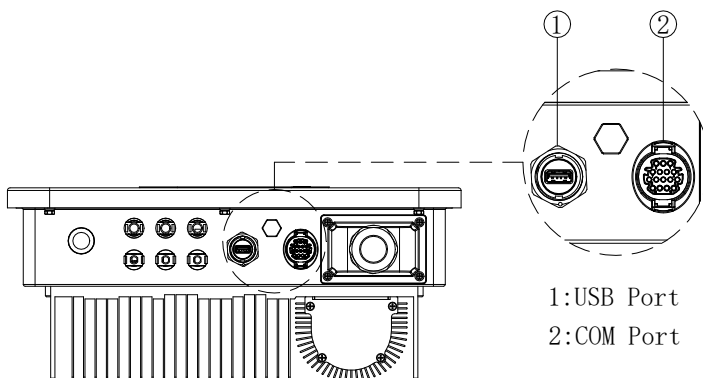

Figure 4- 16 Communications port

4.5.1. USB Port

Port Description:

USB port	USB flash disk access	Use for updating the software
	USB acquisition stick (WIFI or Ethernet) access	Use for remote data acquisition and upgrading of inverter

Procedure:

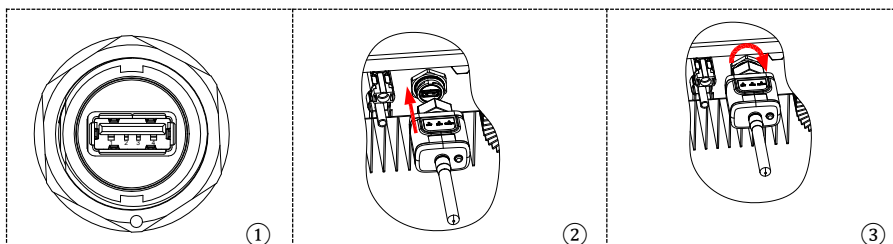

For details, please refer to the user manual of USB acquisition stick.

4.5.2. COM—Multi function communication port

Name	Type	Outer diameter (mm)	Area (mm ²)
RS485 Communication Wire	Outdoor shielded twisted pair meets local standards	2 or 3 core: 4~8	0.25~1

Table 4- 3 Recommend COM cable size

Port Description:

PIN	Define	Function	Note
1	RS485A	RS485 signal+	Wire connection monitoring or multiple inverter monitoring
2	RS485A	RS485 signal+	
3	RS485B	RS485 signal-	
4	RS485B	RS485 signal-	
5	Electric meter RS485A	Electric meter RS485 signal+	Wire connection Electric meter
6	Electric meter RS485B	Electric meter RS485 signal-	
7	GND.S	Communication ground	As RS485 signal ground or DRMS port ground
8	DRM0	Remote shut down	DRMS port
9	DRM1/5	DRMS port logical IO	
10	DRM2/6		
11	DRM3/7		
12	DRM4/8		
13-16	Blank PIN	N/A	N/A

Table 4- 4 Com port description

Procedure:

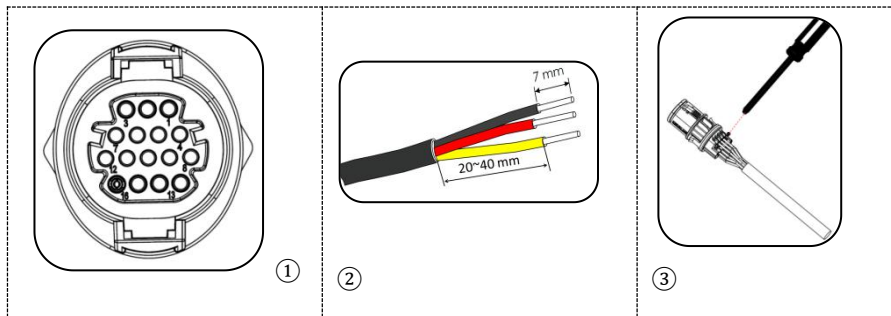

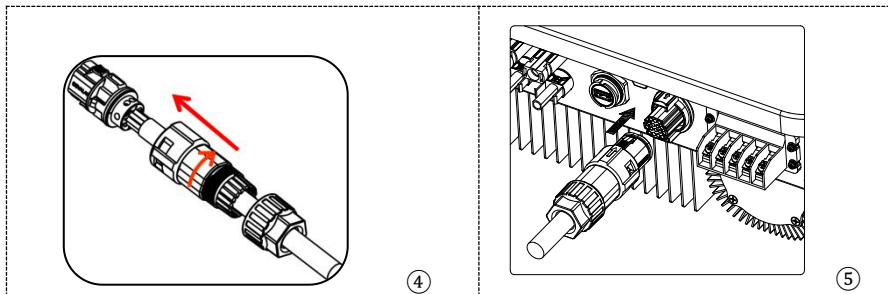

4.5.3. Communications Port Description

Logic interface

(a) Logic interface for AS/NZS 4777.2:2020, also known as inverter demand response modes (DRMs).

The inverter will detect and initiate a response to all supported demand response commands within 2 s. The inverter will continue to respond while the mode remains asserted.

Pin NO.	Function
9	DRM1/5
10	DRM2/6
11	DRM3/7
12	DRM4/8
7	GND
8	DRM0

Table 4- 5 Function description of the DRMs terminal

NOTE: Supported DRM command: DRM0, DRM5, DRM6, DRM7, DRM8.

(b) Logic interface for VDE-AR-N 4105:2018-11, is in order to control and/or limit the inverter's output power.

The inverter can be connected to a RRCCR (Radio Ripple Control Receiver) in order to dynamically limit the output power of all the inverters in the installation.

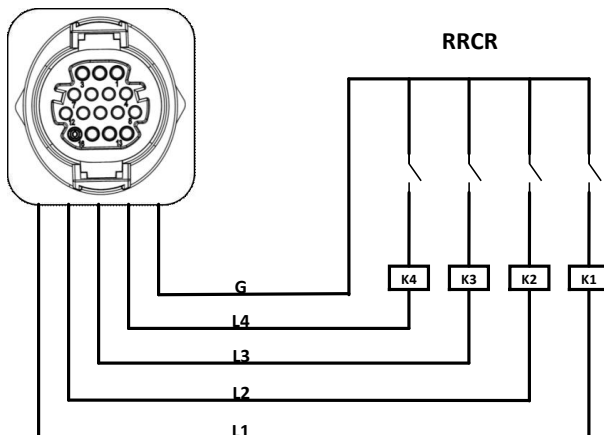

Figure 4- 17 Inverter – RRCR Connection

Pin NO.	Pin name	Description	Connected to (RRCR)
9	L1	Relay contact 1 input	K1 - Relay 1 output
10	L2	Relay contact 2 input	K2 - Relay 2 output
11	L3	Relay contact 3 input	K3 - Relay 3 output
12	L4	Relay contact 4 input	K4 - Relay 4 output
7	G	GND	Relays common node

Table 4- 6 Function description of the terminal

Relay status: close is 1, open is 0

L1	L2	L3	L4	Active Power	Cos(φ)
1	0	0	0	0%	1
0	1	0	0	30%	1
0	0	1	0	60%	1
0	0	0	1	100%	1

Table 4- 7 4 port RRCR power levels

(c) Logic interface for EN50549-1:2019, is in order to cease active power output within five seconds following an instruction being received at the input interface.

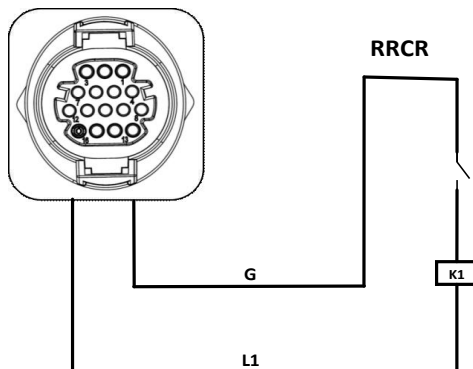

Figure 4- 18 Inverter – RRCR Connection

Pin NO.	Pin name	Description	Connected to (RRCR)
9	L1	Relay contact 1 input	K1 - Relay 1 output
7	G	GND	K1 - Relay 1 output

Table 4- 8 Function description of the terminal

Relay status: close is 1, open is 0

L1	Active Power	Power drop rate	Cos(φ)
1	0%	<5 seconds	1
0	100%	/	1

Table 4- 9 1 port RRCR power level

Step4 Insert the terminal as per the printed label, and then tighten the screws to fix the waterproof cover, rotate the cable gland clockwise to fasten it securely.

This topic describes the functions of the RS485 and WIFI.

RS485

By RS485 interface, transfer the inverter power output information, alarm information, operation state to the PC terminal or local data acquisition device, then uploaded to the server.

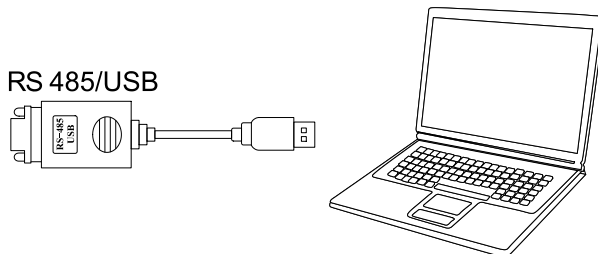

Figure 4- 19 Picture of the RS485/USB converter and PC terminal

If only one SOFAR 3.3~12KTLX-G3 is used, use a communication cable, refer to **section 4.5.2** for COM pin definition, and choose either of the two RS485 ports.

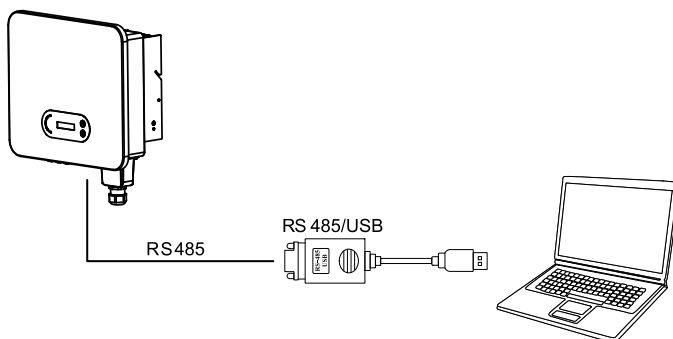

Figure 4- 20 Connecting a single inverter via RS485

If multiple SOFAR 3.3~12KTLX-G3 are used, connect all SOFAR 3.3~12KTLX-G3 in daisy chain mode over the RS485 communication cable. Set different Modbus address (starting from 1 to 31) for each inverter in the chain.

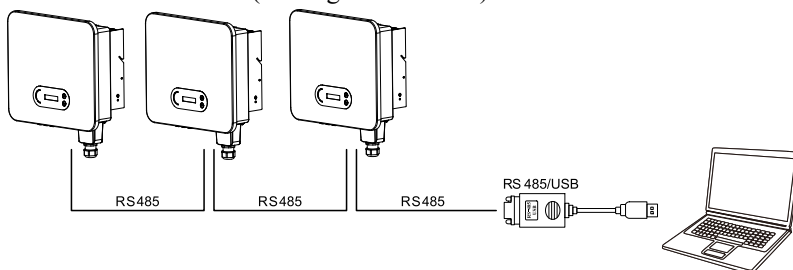

Figure 4- 21 Daisy chain multiple inverters via RS485

Register remote monitoring of SOFAR 3.3~12KTLX-G3 at its relevant website or APP according to monitoring device SN.

WIFI / Ethernet

By the USB acquisition stick (WIFI / Ethernet), transfer the inverter power output information, alarm information, operation state to the PC terminal or local data acquisition device, then uploaded to the server. Register remote monitoring of SOFAR 3.3~12KTLX-G3 at its relevant website or APP according to monitoring device SN.

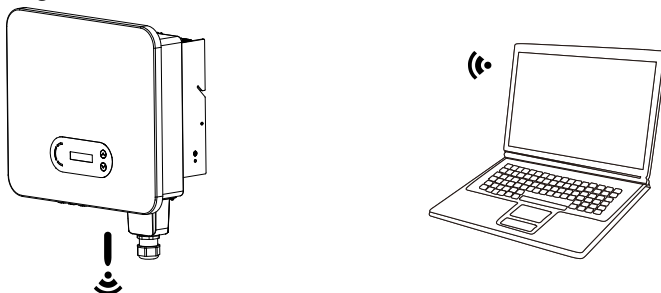

Figure 4-22 Connecting a single wifi logger to wireless router

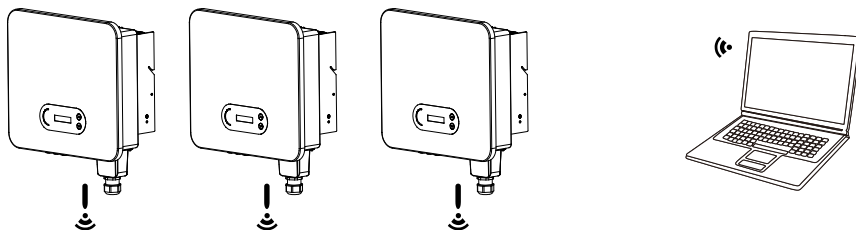

Figure 4-23 Connecting multiple wifi loggers to wireless router



- The length of the RS485 communication cable should be less than 1000 m.
- The length of the WIFI communication cable should be less than 100 m.
- If multiple SOFAR 3.3~12KTLX-G3 are connected to the

Note

monitoring device over an RS485/USB converter, a maximum of 31 inverters can be connected in a daisy chain.

The operation information (generated energy, alert, operation status) of the inverter can be transferred to PC or uploaded to the server via WiFi/GPRS. Users can choose to use web or APP for monitoring according to their needs. They need to register an account and add the device with the WiFi/GPRS logger serial number. The SN number of the WiFi/GPRS is printed on the box and the WiFi/GPRS.

Web: <https://home.solarmanpv.com>

(Recommended browser: Chrome, Firefox, and Edge).

APP: Android: Go to Android Market and search “SolarMAN smart”.

IOS: Go to App Store and search “SolarMAN smart”.

SolarMAN-3.0- Web User Manual,

Please visit the <https://doc.solarmanpv.com/web/#/7>

SolarMAN-App User Manual,

Please visit the <https://doc.solarmanpv.com/web/#/14>

Meter

Generation and Export Limit Control functions for the inverter are available but require the use of an external measurement device to obtain grid information.

Note: Meter is supplied separately to the inverter. Please contact your distributor to order a meter.

Connect the wires according to the wiring method as shown in Figure 4-24, and then enable Anti-Reflux Power function and set the Reflux Power limit on the menu interface of the machine. Hard Anti-Reflux also needs to be enabled to take effect. Refer to <6.3 Main interface→A Enter Setting> in this manual for specific operation methods.

Note:

Anti-Reflux Function = Export Limit function

Reflux Power = Export Power

Hard Anti-Reflux control = Hard Export limit control

Anti-Reflux Control = Soft Export limit control

When Anti-Reflux function is enabled, the reflux power of point of common coupling (PCC) will be limited to the set Reflux Power limit.

Both Hard Anti-Reflux Control and Anti-Reflux Control can be used together. However, when Hard Anti-Reflux control is enabled, Anti-Reflux power limit cannot exceed the Hard Anti-Reflux power limit. The limit value is reported to overload protection.

When communication signal with the electricity meter is lost, the output power of the inverter is limited to the value of soft export limit and does not enter the state of fault protection. When Hard anti reflux control is enabled, a loss of communication with the meter will cause the inverter to enter into a fault protection state.

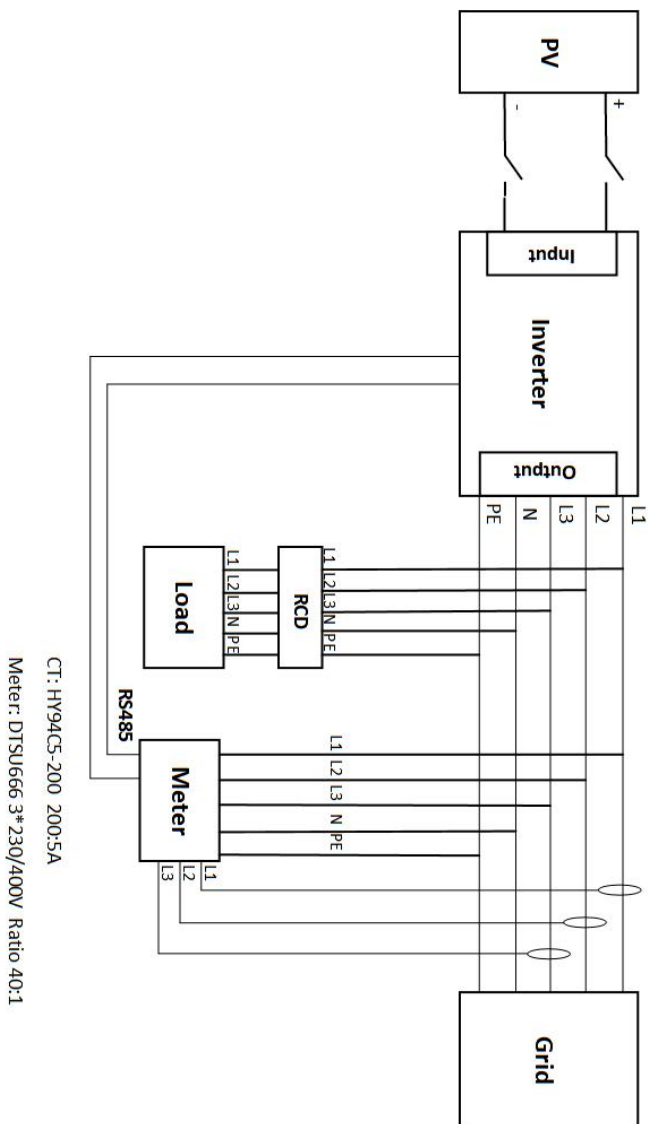



Figure 4- 24 Electrical connections (Meter + CT)

5. Commissioning of inverter

Outline this Chapter

Introduce SOFAR 3.3~12KTLX-G3 safety inspection and start processing

5.1. Cable Connection Inspection

 Attention	<p>For first time operation, check the AC voltage and DC voltage are within the acceptable range</p>
 Warning	<p>Multi inverter combination cannot be connected</p>

AC grid connection

Use multimeter to confirm that three lines and PE line are connect correctly. DC pv connection.

Use multimeter to confirm that positive pole and negative pole of PV strings, and the Voc of each string is lower than the inverter max DC input.

5.2. Start Inverter

Step 1: Turn ON the DC switch.

Step 2: Turn ON the AC circuit breaker.

When the DC power generated by the solar array is enough, the SOFAR 3.3~12KTLX-G3 inverter will start automatically. Screen showing “normal” indicates correct operation.

NOTE 1: Choose the correct country code. (refer to section 6.3 of this manual)

NOTE 2: Different distribution network operators in different countries have different requirements regarding grid connections of PV grid connected inverters.

Therefore, it's very important to make sure that you have selected the correct country code according to requirements of local authority. Please consult

qualified electrical engineer or personnel from electrical safety authorities about this.

Shenzhen SOFARSOLAR Co., Ltd. is not responsible for any consequences arising out of incorrect country code selection.

If the inverter indicates any fault, please refer to Section 7.1 of this manual — trouble shooting for help.

5.3. Shutdown inverter

Step 1: Turn OFF the AC circuit breaker.

Step 2: Turn OFF the DC switch.

5.4. Setting power quality response modes

Once the power quality and grid settings have been selected at commissioning, these settings will be locked, end customers cannot modify by themselves. These setting require professional and technical personnel to conduct them by issuing and transmitting instructions on the remote monitoring platform, on the premise that the logger is installed (WiFi/GPRS/Ethernet). And the account must be authorised by SOFARSOLAR.

Power quality settings can be set/view/changed by logging onto solarmanpv.com.

Access to solarmanpv.com is restricted to authorised personnel only (refer to Section 4.5.3 for instructions on accessing solarmanpv.com).

An account must be created to use solarmanpv.com.

Technical personnel can send control instructions on the monitoring page to modify the mode and parameters of the machine, and the corresponding instructions need to be provided by internal professionals.

Once set chosen country grid code has been selected, the current inverter settings, including firmware version can be viewed under the “System Info” menu. Please refer to section 6.3 Main Interface.

6. Operation interface

Outline of this chapter

This section introduces the display, operation, buttons and LED indicator lights of SOFAR 3.3~12KTLX-G3 Inverter.

6.1. Operation and Display Panel

Buttons and Indicator lights

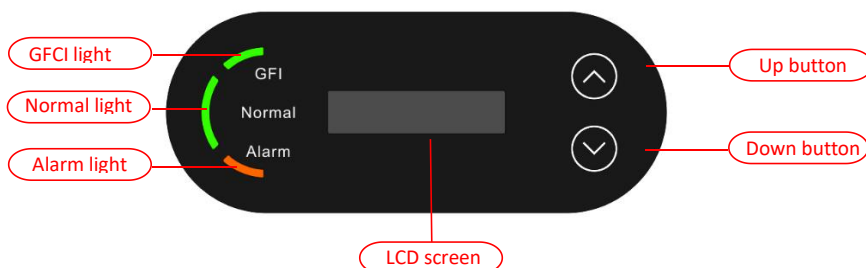

Button:

- “^” Short press UP button = go up
- “^” Long press UP button = exit menu or current interface
- “v” Short press DOWN button = go down
- “v” Long press DOWN button = enter menu or current interface

Indicator Lights:

- “GFI” Red light ON = GFCI faulty
- “Normal” Green light flashing = counting down or checking
- “Normal” Green light ON = Normal
- “Alarm” Red light ON= recoverable or unrecoverable faulty

6.2. Standard Interface

LCD interface indicated inverter status, alarm information, communication connection, PV input current and voltage, grid voltage, current and frequency, today generation, total generation.

Inverter working status, PV 1 input voltage and current

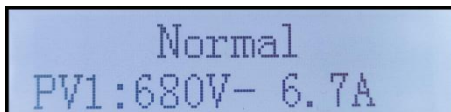

Normal
PV1:680V- 6.7A

Inverter working status, PV 2 input voltage and current

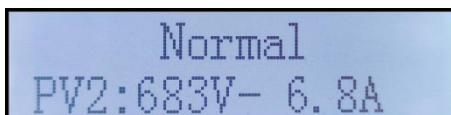

Normal
PV2:683V- 6.8A

Inverter working status, PV generated power

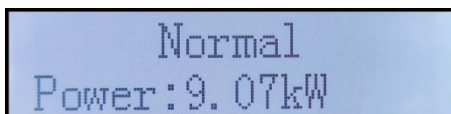

Normal
Power:9.07kW

Inverter working status, today generated electricity

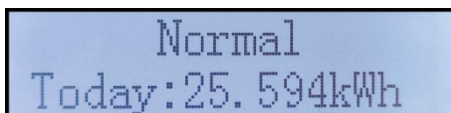

Normal
Today:25.594kWh

Inverter working status, total generated electricity

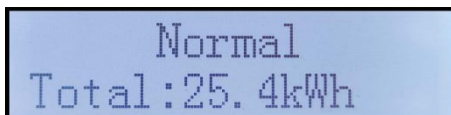

Normal
Total:25.4kWh

Inverter working status, grid voltage and current

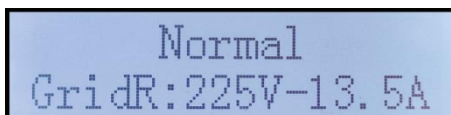

Normal
GridR:225V-13.5A

Normal
GridS:228V-13.4A

Normal
GridT:224V-13.4A

Inverter working status, grid voltage and frequency

Normal
Grid:226V-50.0Hz

Inverter working status, USB status

Normal
Power:9.07kW 

Inverter faulty alarm

GridUVP
Power:0.00kW

When control board successfully connected with communication board, the LCD display the current state of the inverter, display as shown in the figure below.

Wait 3 s
Power:0.00kW

Check
Power:0.00kW

Normal
Today:25.594kWh

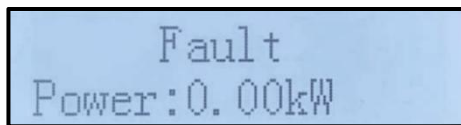

Inverter states includes: wait, check, normal and fault

Wait: Inverter is waiting to Check State when reconnect the system. In this state, grid voltage value is between the max and min limits and so on; If not, Inverter will go to Fault State or Permanent State.

Check: Inverter is checking isolation resistor, relays, and other safety requirements. It also does self-test to ensure inverter software and hardware are well functional. Inverter will go to Fault State or Permanent State if any error or fault occurs.

Normal: Inverter enter to Normal State, it is feeding power to the grid; inverter will go to Fault State or Permanent state if any error or fault occurs.

Fault: Fault State: Inverter has encountered recoverable error. It should recover if the errors disappear. If Fault State continues; please check the inverter according error code.

When the control board and communication board connection fail, the LCD display interface as shown in the figure below.

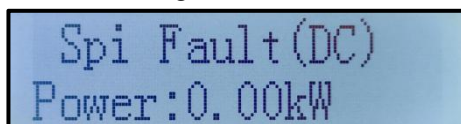

6.3. Main Interface

Long press the down button under standard interface to enter into main interface, Main interface including below information:

Normal	-----Long press DOWN button
	1.Enter Setting
	2.Event List
	3.SystemInfo
	4.Display Time
	5.Software Update

(A)Enter setting Interface as below :

1.Enter Setting	-----Long press DOWN button	
	1.Set Time	8.Set Input mode
	2.Clear Energy	9.Set Language
	3.Clear Events	10.Set Reflux P
	4.Country Code	11.Logic Interface
	5.On-Off Control	12.IV Curve Scan
	6.Set Energy	13.Autotest Fast
	7.Set Address	14.Autotest STD

Long press the button to Enter the main interface of "1. Enter Setting" and long press to enter the setting menu. You can select the content you want to set by short pressing the button.

Note1: Some settings need to enter the password (the default password is 0001), when entering the password, short press to change the number, long press to confirm the current number, and long press after entering the correct password. If "password error, try again" appears, you will need to re-enter the correct password.

1. Set Time

Set the system time for the inverter.

2. Clear Energy

Clean the inverter of the total power generation.

3. Clear Events

Clean up the historical events recorded in the inverter.

4. Country Code

This menu is where you can select the country grid parameters, alternatively you can use the mobile APP. To import a country profile you will require the use of a USB drive. Once you insert a USB drive with a valid file you can then select and import it in the "Set SafetyPara" menu.

To use the Bluetooth APP to select the correct country code, the account must be linked and authorised as an installer. Once the country is set, it is read-only and can only be viewed and not modified by the end user.

Please contact and discuss with SOFARSOLAR technical support if you require a non standard parameter set.

Code		Country	Code		Country
000	000*	Germany VDE4105	024	000	Cyprus
	001	Germany BDEW	025	000	India
	002*	Germany VDE0126	026	000	Philippines
001	000	Italia CEI-021 Internal	028	000	New Zealand
	001*	Italia CEI-016 Italia		000	Brazil
	002*	Italia CEI-021 External		001	Brazil LV
	003	Italia CEI0-21 In Areti		002	Brazil 230
002	000	Australia A	029	003	Brazil 254
	008	Australia-B		000*	Slovakia VSD
	009	Australia-C		001*	Slovakia SSE
003	000	Spain RD1699		002*	Slovakia ZSD
004	000*	Turkey	033	000*	Ukraine
005	000	Denmark	034	000	Norway
	001	Denmark TR322		001	Norway-LV
006	000*	Greece Continent	035	000	Mexico LV
	001*	Greece island	038	000	Wide-Range-60Hz
007	000*	Netherland	039	000*	Ireland EN50438
008	000*	Belgium	040	000	Thailand PEA
009	000	UK G59/G99		001	Thailand MEA
		001	UK G83/G98	042	000
010	000	China	044	000	South Africa
	001	China Taiwan	046	000*	Dubai DEWG
011	000*	France		001	Dubai DEWG MV
		001	France FAR Arrete23	107	000*
012	000	Poland	108	000*	Lithuania
013	000	Austria Tor Erzeuger			
014	000	Japan			
018	000	EU EN50438			
	001*	EU EN50549			
019	000	IEC EN61727			
020	000	Korea			
021	000	Sweden			
022	000	Europe General			

Table 6- 1 List of available grid codes

For The Australian Market:

For compliance with AS/NZS 4777.2:2020 please select from

- 002-000 Australia A (Australia Region A)

- 002-008 Australia B (Australia Region B)
- 002-009 Australia C (Australia Region C)

Please contact your local grid operator for which option to select

Note: By selecting 002-000 Australia A, 002-008 Australia B or 002-009 Australia C the power quality response mode and grid protection settings will be reset to their default values for Australia Region A, B, C respectively.

Default grid settings for different regions are shown in the following table:

Protective function	Protective function limit	Trip delay time	Maximum disconnection time
Undervoltage 2(V<<)	70V	1s	2s
Undervoltage 1(V<)	180V	10s	11s
Overvoltage 1(V>)	265V	1s	2s
Overvoltage 2(V>)	275V	-	0.2s

	Region	Australia A	Australia B	Australia C	New Zealand
Under-frequency 1 (F<)	Protective function limit value	47Hz	47Hz	45Hz	45Hz
	Trip delay time	1s	1s	5s	1s
	Maximum disconnection time	2s	2s	6s	2s
Over-frequency 1 (F>)	Protective function limit value	52Hz	52Hz	55Hz	55Hz
	Trip delay time	-	-	-	-
	Maximum disconnection time	0.2s	0.2s	0.2s	0.2s

Default volt-watt settings for different regions are shown in the following table:

Region	Default value	V_{L2}	V_{L1}	V_{W1}	V_{W2}
Australia A	Voltage	207	215	253	260
	Inverter output (P) % of S_{rated}	20%	100%	100%	20%
Australia B	Voltage	195	215	250	260
	Inverter output (P) % of S_{rated}	0%	100%	100%	20%
Australia C	Voltage	207	215	253	260

	Inverter output (P) % of S_{rated}	20%	100%	100%	20%
--	--------------------------------------	-----	------	------	-----

Default volt-var settings for different regions are shown in the following table:

Region	Default value	V_{V1}	V_{V2}	V_{V3}	V_{V4}
Australia A	Voltage	207	220	240	258
	Inverter reactive output (Q) % of S_{rated}	44% supplying	0%	0%	60% sinking
Australia B	Voltage	205	220	235	255
	Inverter reactive output (Q) % of S_{rated}	30% supplying	0%	0%	40% sinking
Australia C	Voltage	215	230	240	255
	Inverter reactive output (Q) % of S_{rated}	44% supplying	0%	0%	60% sinking

5. On-Off Control

Inverter on-off local control.

6. Set Energy

Set the total power generation. You can modify the total power generation through this option.

7. Set address

Set the address (when you need to monitor multiple inverters simultaneously), Default 01.

8. Set Input mode

SOFAR 3.3~12KTLX-G3 has 2 MPPT circuit, each MPPT circuit can work interdependently, or divided into parallel mode. User can change the setting according to the configuration

9. Set Language

Set the inverter display language.

10. Set Reflux P

Enable or disable the export limiting function of the inverter. This function requires to be used with an external CT (CT mode) or an external smart meter (ElecM mode, via RS485), please refer to this manual 4.5.3 CT for details.

“Enter”	1Enter setting	“OK”	1 Set Time	
	2 Event List		2 Clean Energy	
“Up”↑	3 System Info	“Up”↑	3 Clean Events	
	4 Display Time		
“Down”↓	5 Software Update	“Down”↓	10 Set Reflux P	“OK”
			Input password!	
“OK”	****	Input 0001	0001	“OK”
			Anti Reflux Control	
				Hard Anti Reflux Control

Anti Reflux Control	“OK”	Enable	“OK”	*.**KW	Input the allowable export power
		Disable			
Hard Anti Reflux Control	“OK”	Enable	“OK”	*.**KW	Input the allowable export power
		Disable			

Press “Up” or “Down” to change the value of the first digit. Press “OK” to switch to second digit.

Press “Up” or “Down” to change the value of the second digit. After inputting all digit press “OK” to confirm.

11. Logic interface

Enable or disable logical interfaces. It is use for below standard Australia (AS4777), Europe General (50549), German (4105)

12. IV Curve Scan

Shadow scanning, when the component is blocked or abnormal, causing multiple power peaks, by enabling this function, the peak point of maximum power can be tracked.

13. Autotest Fast

13.Autotest Fast	OK	Start Autotest	Long press the“V” to start	
		Testing 59.S1...		Wait
		↓		
		Test 59.S1 OK!		Wait
		↓		
		Testing 59.S2...		Wait
		↓		
		Test 59.S2 OK!		Wait
		↓		

Testing 27.S1...	
↓	Wait
Test 27.S1 OK!	
↓	Wait
Testing 27.S2...	
↓	Wait
Test 27.S2 OK!	
↓	Wait
Testing 81>S1...	
↓	Wait
Test 81>S1 OK!	
↓	Wait
Testing 81>S2...	
↓	Wait
Test 81>S2 OK!	
↓	Wait
Testing 81<S1...	
↓	Wait
Test 81<S1 OK!	
↓	Wait
Testing 81<S2...	
↓	Wait
Test 81<S2 OK!	
↓	Long press the“V”
Auto Test OK!	
↓	Short press the“V”
59.S1 threshold 253V 900ms	
↓	Short press the“V”
59.S1: 228V 902ms	
↓	Short press the“V”
59.S2 threshold 264.5V 200ms	
↓	Short press the“V”
59.S2: 229V 204ms	
↓	Short press the“V”
27.S1 threshold 195.5V 1500ms	
↓	Short press the“V”
27.S1: 228V 1508ms	
↓	Short press the“V”
27.S2 threshold 34.5V 200ms	
↓	Short press the“V”
27.S2: 227V 205ms	
↓	Short press the“V”
81>.S1 threshold 50.5Hz	

100ms	
↓	Short press the“V”
81>.S1 49.9Hz 103ms	
↓	Short press the“V”
81>.S2 threshold 51.5Hz 100ms	
↓	Short press the“V”
81>.S2 49.9Hz 107ms	
↓	Short press the“V”
81<.S1 threshold 49.5Hz 100ms	
↓	Short press the“V”
81<.S1 50.0Hz 105ms	
↓	Short press the“V”
81<.S2 threshold 47.5Hz 100ms	
↓	Short press the“V”
81<.S2 50.1Hz 107ms	

14. Autotest STD

14.Autotest STD Long press the “V”

The test procedure is same as Autotest Fast, but it’s much more time consuming.

(B) Event List:

Event List is used to display the real-time event records, including the total number of events and each specific ID No. and happening time. User can enter Event List interface through main interface to check details of real-time event records, Event will be listed by the happening time, and recent events will be listed in the front. Please refer to below picture. Long press the button and short press the button to turn the page in standard interface, then enter into “2. Event List” interface.

2. Event List	
1. Current event	2. History event
Fault information	001 ID04 06150825 (Display the event sequence number, event ID number, and event occurrence time)

(A) “SystemInfo” Interface as below

3.SystemInfo -----Long press DOWN button

1.Inverter Type
2.Serial Number
3.Soft Version
4.Hard Version
5.Country
6.Modbus Address
7.Input Mode

The user enters the main menu by long pressing the DOWN button, short press and turns the page to select menu contents, then long press the button to enter "3. SystemInfo". Turning the page down can select the system information to view.

(B) Display Time

Long press the button and short press the button to turn the page in the standard user interface to enter into "4. Display Time", then long press the button to display the current system time.

(C) Software Update

User can update software by USB flash disk, SOFARSOLAR will provide the new update software called firmware for user if it is necessary, the user needs to copy the upgrade file to the USB flash disk.

6.4. Updating Inverter Software

SOFAR 3.3~12KTLX-G3 inverter offer software upgrade via USB flash drive to maximize inverter performance and avoid inverter operation error caused by software bugs.

Step 1: Turn off AC circuit breaker and DC switch, remove the communication board cover as below figure. If the RS485 line has been connected, please release the waterproof nut first and make sure the communication line is no longer the force. Then remove the waterproof cover.

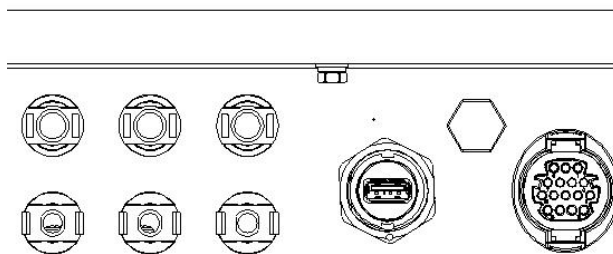

Figure 6-1 Remove communication broad cover

Step 2: Insert USB into computer

Step 3: SOFARSOLAR service team will send the software code to user, after user received the file, please decompress the files and the original folder to a USB flash drive.

Step 4: Insert USB flash disk into the USB port of inverter

Step 5: Then turn on DC switch, screen show “recoverable fault” (as AC circuit breaker still open, inverter cannot detect grid power, so it may show “recoverable fault”)

Step 6 : Long press “DOWN” button to enter the menu, then short press “DOWN” button to find "5. Software Update” in the LCD display, long press “DOWN” button to enter input password interface.

Step 7 : Input the password, if password is correct, and then begin the update process.

Step 8 : System update main DSP, slave DSP and ARM in turns. If main DSP update success, the LCD will display “Update DSP1 Success”, otherwise display "Update DSP1 Fail"; If slave DSP update success, the LCD will display"Update DSP2 Success", otherwise display "UpdateDSP2 Fail".

Step 9: After the update is completed, turn off the DC breaker, wait for the LCD screen extinguish, then recover the communication waterproof and then turn on the DC breaker and AC breaker again, the inverter will enter the running state. User can check the current software version in SystemInfo>>>3.SoftVersion.

Note: If screen shows “Communication fail”, “Update DSP1 fail”, “Update

DSP2 fail” please turn off the DC switch, wait for the LCD screen turn off, then turn on the DC switch again, then Continue to update from step 5.

7. Trouble shooting and maintenance

7.1. Troubleshooting

This section describes the potential errors for this product. Please read carefully for the following tips when doing the troubleshooting:

- 1) Check the warning message or faulty codes on the inverter information panel
- 2) If not any error code display on the panel, please check the following lists:
 - Is inverter be installed in a clean, dry, ventilated environment?
 - Is the DC switch turn off?
 - Are the cable cross section area and length meet the requirement?
 - Are the input and output connection and wiring in good condition?
 - Are the configuration settings correctly for the particular installation?

This section contains the potential errors, resolution steps, and provide users with troubleshooting methods and tips

Earth Fault Alarm

This inverter complies with AS/NZS 5033 for earth fault alarm monitoring.

If an Earth Fault Alarm occurs, the fault will be displayed on the LCD screen, the red light will be on, and the fault can be found in the history of the fault. For the machine installed with Wi-Fi/GPRS, the alarm information can be seen on the corresponding monitoring website, and can also be received by the APP on the mobile phone.

The process to check the event list can refers to Manual Chapter 7.3 (B)

Even List ID	Event List Name	Description	Even Reason & Solution
ID01	GridOVP	The power grid voltage is too high	If the alarm occurs occasionally, the possible cause is that the electric grid is abnormal occasionally. inverter automatically returns to normal operating status when the electric grid's back to normal.
ID02	GridUVP	The power grid voltage is too low	If the alarm occurs frequently, check whether the grid voltage/frequency is within the acceptable range. If no, contact technical support. If yes, check the AC circuit breaker and AC wiring of the inverter.
ID03	GridOFP	The power grid frequency is too high	If the grid voltage/frequency is within the acceptable range and AC wiring is correct, while the alarm occurs repeatedly, contact technical support to change the grid over-voltage, under-voltage, over frequency, under-frequency
ID04	GridUFP	The power grid frequency is too low	protection points after obtaining approval from the local electrical grid operator.
ID05	GFCIFault	GFCI Fault	If the fault occurs occasionally, the possible cause is that the external circuits are abnormal occasionally. inverter automatically returns to normal operating status after the fault is rectified. If the fault occurs frequently and lasts a long time, check whether the insulation resistance between the PV array and earth(ground) is too low, then check the insulation conditions of PV cable.
ID06	OVRT	OVRT faulty	There are internal faults of inverter, turn OFF the "DC switch", wait for 5 minutes, then turn ON the "DC switch". Check whether the fault is rectified. If no, please contact technical support.
ID07	LVRT	LVRT faulty	
ID08	IslandFault	Islanding faulty	
ID09	GridOVInstant1	Grid instantaneous voltage too high 1	
ID10	GridOVInstant2	Grid instantaneous voltage too high 2	
ID11	VGridLineFault	Grid Line voltage Faulty	
ID12	InvOVP	Inverter overvoltage	

ID17	HwADFault IGrid	The grid current sampling error	
ID18	HwADFault DCI	The DCI sampling error	
ID19	HwADFault VGrid(DC)	Grid voltage sampling faulty (DC side)	
ID20	HwADFault VGrid(AC)	Grid voltage sampling faulty (AC side)	
ID21	GFCIDevic eFault(DC)	Current leakage sampling (DC side)	There are internal faults of inverter, turn OFF the “DC switch”, wait for 5 minutes, then turn ON the “DC switch”. Check whether the fault is rectified. If no, please contact technical support.
ID22	GFCIDevic eFault(AC)	Current leakage sampling (AC side)	
ID23	HwADFault IdcBranch	Current Branch sampling faulty	
ID24	HwADFault Idc	DC input current sampling faulty	
ID29	ConsistentF ault_GFCI	The GFCI sampling value between the master DSP and salve DSP is not consistent	
ID30	ConsistentF ault_Vgrid	The Grid voltage sampling value between the master and salve is not consistent	
ID31	ConsistentF ault_DCI	3 lines' DCI consistency error	There are internal faults of inverter, turn OFF the “DC switch”, wait for 5 minutes, then turn ON the “DC switch”. Check whether the fault is rectified. If no, please contact technical support.
ID33	SpiCommF ault(DC)	SPI Communication Faulty (DC side)	
ID34	SpiCommF ault(AC)	SPI Communication Faulty (AC side)	
ID35	SChip_Faul t	Chip Faulty (DC side)	
ID36	MChip_Fau lt	Chip Faulty (AC side)	
ID37	HwAuxPow erFault	Auxiliary power fault	
ID41	RelayFail	Relay faulty	Please check whether the resistance to ground of PV string is too low and whether the insulation of PV cable is damaged. If the use method is not ruled out, please contact the new energy customer service of Capital Airlines.
ID42	IsoFault	Low isolation faulty	
ID43	PEConnect Fault	Ground faulty	

ID44	PvConfigError	Input mode incorrect	Please check the wiring of PV string, whether each PV input is independent. If the use method is not ruled out, please contact the new energy customer service of Capital Airlines.
ID45	CT Disconnect	CT Fault	Please check the wiring of input, output and communication according to the user's manual. If the use method is not ruled out, please contact the new energy customer service of Capital Airlines.
ID46	ReversalConnection	Input reverse connection error	
ID47	Reserved	Reserved	It is internal fault of inverter.
ID48	SNTYPEFault	SN doesn't match Type	
ID49	Reserved	Reserved	Ensure the installation position and installation method meet the requirements of this user manual. Check whether the ambient temperature of the installation position exceeds the upper limit. If yes, improve ventilation to decrease the temperature. Check whether the inverter has dust and dust, whether there are foreign matters blocking the fan at the air inlet. If so, please improve the ventilation and heat dissipation of the environment. It is recommended that the inverter should be cleaned once every half a year.
ID50	TempFault_HeatSink1	Heat sink1 over-temperature protection	
ID51	Reserved	Reserved	
ID52	Reserved	Reserved	
ID53	Reserved	Reserved	
ID54	Reserved	Reserved	
ID55	Reserved	Reserved	
ID57	TempFault_Env1	environment temperature1 protection	
ID58	Reserved	Reserved	
ID59	TempFault_Inv1	Model 1 over-temperature protection	
ID60	Reserved	Reserved	
ID61	Reserved	Reserved	
ID65	VbusRmsUnbalance	Unbalanced RMS value of bus voltage	

ID66	VbusInstant Unbalance	Unbalanced instantaneous value of bus voltage	
ID67	BusUVP	Bus undervoltage during grid connection	If the configuration of the PV array is correct, could be the sun irradiation is too low. Once sun irradiation back to normal, inverter will work back normal
ID68	BusZVP	Bus voltage is low	
ID69	PVOVP	PV overvoltage	
ID70	Reserved	Reserved	
ID71	LLCBusOV P	LLCBUS overvoltage	
ID72	SwBusRms OVP	Inverter bus voltage overvoltage software	
ID73	SwBusInsta ntOVP	Inverter bus voltage instantaneous value overvoltagesoftware	There are internal faults of inverter, turn OFF the “DC switch”, wait for 5 minutes, then turn ON the “DC switch”. Check whether the fault is rectified. If no, please contact technical support.
ID81	Reserved	Reserved	There are internal faults of inverter, turn OFF the “DC switch”, wait for 5 minutes, then turn ON the “DC switch”. Check whether the fault is rectified. If no, please contact technical support.
ID82	DciOCP	Dci overcurrent faulty	
ID83	SwOCPInsta nt	Output instantaneous current protection	
ID84	SwBuckBo ostOCP	BuckBoost software overcurrent	
ID85	SwAcRmsO CP	Output RMS current protection	
ID86	SwPvOCPI nstant	PV overcurrent software protection	
ID87	IpvUnbalan ce	PV parallel unbalance	
ID88	IacUnbalan ce	Output current unbalance	
ID89	AFCIFault	Arc Fault	
ID97	HwLLCBus OVP	LLC hardware overvoltage	

ID98	HwBusOVP	Inverter bus hardware overvoltage	<p>There are internal faults of inverter, turn OFF the “DC switch”, wait for 5 minutes, then turn ON the “DC switch”. Check whether the fault is rectified. If no, please contact technical support.</p>
ID99	HwBuckBoostOCP	BuckBoost hardware overcurrent	
ID100	Reserved	Reserved	
ID102	HwPVOCP	PV hardware overcurrent	
ID103	HwACOCP	AC output hardware overcurrent	
ID110	Overload1	Overload Protection 1	
ID111	Overload2	Overload Protection 2	
ID112	Overload3	Overload Protection 3	
ID113	OverTemp Derating	Overtemperature derating	<p>Ensure the installation position and installation method meet the requirements of this user manual. Check whether the ambient temperature of the installation position exceeds the upper limit. If yes, improve ventilation to decrease the temperature.</p> <p>Check whether the inverter has dust and dust, whether there are foreign matters blocking the fan at the air inlet. If so, please improve the ventilation and heat dissipation of the environment. It is recommended that the inverter should be cleaned once every half a year.</p>
ID114	FreqDerating	Frequency derating	<p>If it occurs frequently, please check whether the grid voltage and grid frequency are within the allowable range of the inverter; if not, please contact the customer service of SOFARSOLAR; if yes, please check whether the connection between the circuit breaker at the AC side and the output cable is normal; if the grid voltage and grid frequency are within the allowable range of the inverter, and the AC side wiring is confirmed to be correct, the alarm still appears frequently. With the approval of the local power operator, please contact the customer service of new energy of Capital Airlines to modify the protection points of over / under voltage and over / under frequency of inverter grid.</p>
ID115	FreqLoading	Frequency loading	
ID116	VoltDerating	Voltage derating	

ID117	VoltLoading	Volatge loading	
ID124	Reserved	Reserved	
ID125	Reserved	Reserved	
ID129	unrecoverHwAcOCP	Output overcurrent hardware permanent fault	There are internal faults of inverter, turn OFF the “DC switch”, wait for 5 minutes, then turn ON the “DC switch”. Check whether the fault is rectified. If no, please contact technical support.
ID130	unrecoverBusOVP	Bus overvoltage permanent fault	
ID131	unrecoverHwBusOVP	Bus overvoltage hardware permanent fault	
ID132	unrecoverIpvUnbalance	PV unbalance current permanent fault	
ID133	Reserved	Reserved	
ID134	unrecoverAcOCPInstant	Output transient overcurrent permanent fault	There are internal faults of inverter, turn OFF the “DC switch”, wait for 5 minutes, then turn ON the “DC switch”. Check whether the fault is rectified. If no, please contact technical support.
ID135	unrecoverIacUnbalance	Output current imbalance permanent fault	
ID137	unrecoverPvConfigError	Input mode configuration permanent fault	
ID138	unrecoverPVOCPIstant	Input overcurrent permanent fault	
ID139	unrecoverHwPVOC	Input hardware overcurrent permanent fault	There are internal faults of inverter, turn OFF the “DC switch”, wait for 5 minutes, then turn ON the “DC switch”. Check whether the fault is rectified. If no, please contact technical support.
ID140	unrecoverRelayFail	Relay permanent fault	

ID141	unrecoverV busUnbalan ce	Bus Unbalanced permanent fault	There are internal faults of inverter, turn OFF the “DC switch”, wait for 5 minutes, then turn ON the “DC switch”. Check whether the fault is rectified. If no, please contact technical support.
ID142	LightningPr otectionFaul tDC	DC SPD failure	
ID143	LightningPr otectionFaul tAC	AC SPD failure	
ID145	USBFault	USB Failure	
ID146	WiFiFault	WIFI failure	
ID147	BluetoothFa ult	Bluetooth failure	
ID148	RTCFault	RTCClock failure	
ID149	CommEEP ROMFault	Communication BOARD EEPROM error	
ID150	CommEEP ROMFault	Communication BOARD FLASH error	
ID151	Reserved	Reserved	
ID152	SafetyVerF ault	Safety Version is Fault	
ID153	SciCommL ose(DC)	SCI communication (DC side)	
ID154	SciCommL ose(AC)	SCI communication (AC side)	
ID155	SciCommL ose(Fuse)	SCI communication (DC current combined side)	
ID156	SoftVerErro r	Inconsistent software version	
ID157	Reserved	Reserved	

ID158	Reserved	Reserved	
ID161	ForceShutdown	ForceShutdown	Remote control enables. If it is not controlled by yourself, please disconnect the DC switch of the inverter, wait for 5 minutes, and then turn on the DC switch. Observe whether the fault has been eliminated after the inverter is restarted. If not, please contact the customer service of SOFARSOLAR.
ID162	RemoteShutdown	RemoteShutdown	
ID163	Drms0Shutdown	Drms0 shut down	
ID165	RemoteDerating	RemoteDerating	
ID166	LogicInterfaceDerating	Logical interface derating	Inverter shows ID83 when remote derating. If no one operate this function, please check the connection (I/O) according to chapter 4.5
ID167	AlarmAntiReflexing	Anti Refluxing derating	
ID169	FanFault1	Fan 1 Alarm	
ID170	FanFault2	Fan 2 Alarm	Check whether the inverter has dust and dust, whether there are foreign matters blocking the fan at the air inlet. If so, please improve the ventilation and heat dissipation of the environment. It is recommended that the inverter should be cleaned once every half a year.
ID171	FanFault3	Fan 3 Alarm	
ID172	FanFault4	Fan 4 Alarm	
ID173	FanFault5	Fan 5 Alarm	
ID174	FanFault6	Fan 6 Alarm	
ID177	Reserved	Reserved	
ID178	Reserved	Reserved	
ID179	Reserved	Reserved	
ID180	Reserved	Reserved	
ID181	Reserved	Reserved	
ID182	Reserved	Reserved	
ID193-ID224	StringFuse_Fault0-31	String fuse open circuit alarm	There are internal faults of inverter, turn OFF the “DC switch”, wait for 5 minutes, then turn ON the “DC switch”. Check whether the fault is rectified. If no, please contact technical support.
ID225-ID240	Reserved	Reserved	/

Table 7- 1 Error Code / Event List

Note: the above table is our general fault ID list, all fault IDs of this inverter can be found in the above table.

7.2. Maintenance

Inverters generally do not need any daily or routine maintenance. But ensure heat sink should not be blocked by dust, dirt or any other items. Before cleaning, make sure that the DC SWITCH is turned OFF and the circuit breaker between inverter and electrical grid is turned OFF. Wait at least for 5 minutes before Cleaning.

✧ Inverter cleaning

Please clean the inverter with an air blower, a dry & soft cloth or a soft bristle brush. Do NOT clean the inverter with water, corrosive chemicals, detergent, etc.

✧ Heat sink cleaning

For the long-term proper operation of inverters, ensure there is enough space around the heat sink for ventilation, check the heat sink for blockage (dust, snow, etc.) and clean them if they exist. Please clean the heat sink with an air blower, a dry & soft cloth or a soft bristle brush. Do NOT clean the heat sink with water, corrosive chemicals, detergent, etc.

8. Technical Data

Outlines of this Chapter

This chapter outline the SOFAR 3.3~12KTLX-G3 model type and technical parameters

Datasheet	SOFAR 3.3KTLX -G3	SOFAR 4.4KTLX -G3	SOFAR 5KTLX -G3-A	SOFAR 5.5KTLX -G3	SOFAR 6.6KTLX -G3	SOFAR 8.8KTLX -G3	SOFAR 11KTLX -G3
Input (DC)							
Recommended Max. PV input power (Wp)	4500	6000	7500	7500	9000	12000	15000
Max. DC power for single MPPT (W)	4500	6000	6000	6000	7500	7500	7500
Number of MPP trackers	2						
Number for DC inputs	1/1	1/1	1/1	1/1	1/1	1/1	1/1
Max. input voltage	1100V						
Start-up voltage	160V						
Rated input voltage	650V						
MPPT operating voltage range	140V-1000V						
Full power MPPT voltage range (V)	160-850	190V-850	240-850	240-850	290-850	380-850	420-850
Max. input MPPT current (A)	15/15	15/15	15/15	15/15	15/15	15/15	15/15
Max. input short circuit current per MPPT (A)	22.5/22.5	22.5/22.5	22.5/22.5	22.5/22.5	22.5/22.5	22.5/22.5	22.5/22.5
Maximum inverter backfeed current to array	0A						
Output (AC)							
Rated power(VA)	3000	4000	5000	5000	6000	8000	10000
Max. AC power (VA)	3300	4400	5000	5500	6600	8800	11000
Rated output current (A)	4.3	5.8	7.2	7.2	8.7	11.6	14.5
Max. output current (A)	5	6.7	7.6	8.3	10	13.3	16.7

Nominal grid voltage	3/N/PE, 230V/400Vac						
Grid voltage range	310Vac-480Vac (According to local standard)						
Nominal frequency	50 Hz						
Grid frequency range	45Hz-55Hz/54Hz-66Hz (According to local standard)						
Active power adjustable range	0~100%						
THDi	<3%						
Power factor	1 default (adjustable+/-0.8)						
Current (inrush)	23.9A /20ms						
Maximum output fault current	66a.c.A ,2μs						
Maximum output overcurrent protection	20.0a.c.A						
Performance							
Max efficiency	98.40%	98.40%	98.40%	98.40%	98.40%	98.50%	98.50%
European weighted efficiency	97.50%	97.50%	97.50%	97.50%	97.50%	98.00%	98.00%
Self-consumption at night	<1W						
MPPT efficiency	>99.9%						
Protection							
DC reverse polarity protection	Yes						
Anti-islanding protection	Yes						
Leakage current protection	Yes						
Ground fault monitoring	Yes						
PV-array string fault monitoring	Yes						
Anti reverse power function	Yes						
DC switch	Not available for AU Market						
AFCI protection	Optional						
Input/ output SPD	PV: type II standard, AC: type II standard						
Protective class	Class I						
Overvoltage category	PV: OVC II, AC mains: OVC III						
Detection methods of	Reactive Power Disturbance						

isolated islands							
Communication							
Communication	RS485/USB/ Bluetooth, Optional: WiFi/GPRS						
General Data							
Ambient temperature range	-30°C~+60°C						
Topology	Transformerless						
Degree of protection	IP65						
Allowable relative humidity range	0~100%						
Max. operating altitude	2000m						
Noise	≤40dB	≤40dB	≤40dB	≤40dB	≤40dB	≤40dB	≤40dB
Weight	17kg	17kg	17kg	17kg	17kg	17kg	18kg
Cooling	Natural					Fan	
Dimension	430*385*182mm						
Display	LCD&Bluetooth +APP						
Standard warranty	10 years						
Standard							
EMC	EN61000-6-1, EN61000-6-2, EN61000-6-3, EN61000-6-4						
Safety standard	IEC62109-1/2, IEC62116, IEC61727, IEC61683, IEC60068(1,2,14,30)						
Grid standard	AS/NZS 4777, VDE V 0124-100, V 0126-1-1, VDE-AR-N 4105, CEI 0-21/CEI 0-16, UNE 206 007-1, EN50549, G98/G99, EN50530, NB/T32004						

Datasheet	SOFAR 8.8KTLX -G3-A	SOFAR 10KTLX -G3-A	SOFAR 11KTLX -G3-A	SOFAR 12KTLX -G3
Input (DC)				
Recommended Max. PV input power (Wp)	12000	15000	15000	18000
Max. DC power for single MPPT (W)	7500/15000	7500/15000	7500/15000	7500/15000
Number of MPP trackers	2			
Number for DC inputs	1/2	1/2	1/2	1/2
Max. input voltage	1100V			
Start-up voltage	160V			
Rated input voltage	650V			
MPPT operating voltage range	140V-1000V			
Full power MPPT voltage range (V)	380-850	420-850	420-850	460-850
Max. input MPPT current (A)	15/30	15/30	15/30	15/30
Max. input short circuit current per MPPT (A)	22.5/45	22.5/45	22.5/45	22.5/45
Maximum inverter backfeed current to array	0A			
Output(AC)				
Rated power (VA)	8000	10000	10000	12000
Max. AC power (VA)	8800	10000	11000	13200
Rated output current (A)	11.6	14.5	14.5	17.4
Max. output current(A)	13.3	15.2	16.7	20
Nominal grid voltage	3/N/PE, 230V/400Vac			
Grid voltage range	310Vac-480Vac (According to local standard)			
Nominal frequency	50Hz			
Grid frequency range	45Hz-55Hz/54Hz-66Hz (According to local standard)			

Active power adjustable range	0~100%			
THDi	<3%			
Power factor	1 default (adjustable+/-0.8)			
Current (inrush)	23.9A /20ms			
Maximum output fault current	66A ,2μs			
Maximum output overcurrent protection	20.0A			
Performance				
Max efficiency	98.50%	98.50%	98.50%	98.50%
European weighted efficiency	98.00%	98.00%	98.00%	98.00%
Self-consumption at night	<1W			
MPPT efficiency	>99.9%			
Protection				
DC reverse polarity protection	Yes			
Anti-islanding protection	Yes			
Leakage current protection	Yes			
Ground fault monitoring	Yes			
PV-array string fault monitoring	Yes			
Anti reverse power function	Yes			
DC switch	Not available for AU Market			
AFCI protection	Optional			
Input/ output SPD	PV: type II standard, AC: type II standard			
Protective class	Class I			
Overvoltage category	PV: OVC II, AC mains: OVC III			
Detection methods of isolated islands	Reactive Power Disturbance			
Communication				

Communication	RS485/USB/ Bluetooth, Optional: WiFi /GPRS			
General Data				
Ambient temperature range	-30°C~+60°C			
Topology	Transformerless			
Degree of protection	IP65			
Allowable relative humidity range	0~100%			
Max. operating altitude	2000m			
Noise	≤40dB	≤40dB	≤40dB	≤40dB
Weight	17kg	18kg	18kg	18kg
Cooling	Fan			
Dimension	430*385*182mm			
Display	LCD&Bluetooth +APP			
Standard warranty	10 years			
Standard				
EMC	EN61000-6-1, EN61000-6-2, EN61000-6-3, EN61000-6-4			
Safety standard	IEC62109-1/2, IEC62116, IEC61727, IEC61683, IEC60068(1,2,14,30)			
Grid standard	AS/NZS 4777, VDE V 0124-100, V 0126-1-1, VDE-AR-N 4105, CEI 0-21/CEI 0-16, UNE 206 007-1, EN50549, G98/G99, EN50530, NB/T32004			

Note: the product may be upgraded in the future. The above parameters are for reference only and are subject to change. Please refer to the real product.

9. Quality Assurance

SOFARSOLAR *Factory’s Warranty Terms and Conditions for Australia

Applicable products

These *Factory’s Warranty Terms and Conditions (“Terms and Conditions”) only applies to the following products, which are distributed and installed in Australia.

Product	Standard warranty period (months)
Inverter	
GRID-TIED (3.3~12KTLX-G3)	120
Accessories	
CT Clamp	24
smart Meter	24
WIFI dongle	24

*This factory warranty is a promise from SOFARSOLAR to its end users on the applicable products listed above.

Definitions

In these Terms and Conditions:

- a) “ACL” means Schedule 2 to the Competition and Consumer Act 2010 (Cth);

- b) “Claim” means any judgment, claim, demand, action, suit or proceeding for damages, debt, restitution, equitable compensation, account, injunctive relief, specific performance or any other remedy, whether by original claim, cross claim or otherwise whether arising at common law, in equity, under statute or otherwise wherever arising, whether known or unknown at the time of these Terms and Conditions, whether presently in contemplation of the parties or not;

- c) “Consequential Loss” means loss or damage, whether direct or indirect, in the nature of, among other things, loss of profits, loss of revenue, loss of

production, liabilities in respect of third parties (whether contractual or not), loss of anticipated savings or business, pure economic loss, loss of opportunity and any form of consequential, special, indirect, punitive or exemplary loss or damages, whether or not a party was advised of the possibility of such loss or damage;

d) “End User” means a person or entity whose order for the purchase of the Product is accepted by SOFARSOLAR;

e) “Loss” means, in relation to any person, any damage, loss, cost, expense or liability incurred by the person or arising from any Claim, action, proceedings or demand made against the person, however arising and whether present or future, fixed or ascertained, actual or contingent and includes Consequential loss;

f) “Product” means any applicable product or products distributed and installed by SOFARSOLAR to the End User as set out in the Table of these Terms and Conditions;

g) “Warranty Period” means the applicable warranty period of the relevant Product as stipulated in the Table of these Terms and Conditions.

Warranty Conditions

Our goods come with guarantees that cannot be excluded under the ACL. You are entitled to a replacement or refund for a major failure and for compensation for any other reasonably foreseeable loss or damage. You are also entitled to have the goods repaired or replaced if goods fail to be of acceptable quality and the failure does not amount to a major failure. Subject to any statutory rights which cannot be excluded (including the ACL) and the terms of any warranty stipulated in these Terms and Conditions, the End User acknowledges that: prior to purchasing the Product, the End User conducted a thorough examination of the Product;

b) SOFARSOLAR made no warranty, condition, description, or representation in relation to the Product outside those contained in these Terms and Conditions;

c) all warranties, conditions, guarantees, and terms in relation to the state,

quality or fitness of the Product and of every other kind whether expressed or implied by use, statute or otherwise are excluded.

To the fullest extent that SOFARSOLAR is able to limit the remedies available under these Terms and Conditions, SOFARSOLAR expressly limits its liability for any breach of a condition or warranty implied by virtue of any applicable legislation (including the ACL) to the following remedies in the event SOFARSOLAR decides a Product to be faulty or otherwise defective during the Warranty Period (or otherwise):

- a) The repair of the Product by SOFARSOLAR whether on-site or off-site;
- b) The replacement of the Product;
- c) The payment of the costs of having the Product repaired.

The payment of the costs of replacing the Product or acquiring equivalent goods. If the Product needs to be replaced, the balance of the Factory's Warranty Period will be applied and transferred to the replacement Product and will continue until its expiry. In this event, the End User will not receive any new warranty card or be entitled to a further Warranty Period, and the replacement Product(s) will be registered by SOFARSOLAR.

Unless otherwise agreed in writing by the parties, the Factory warranty exclusively covers the cost of one (1) freight to the End User, labour and material necessary to regain a faultless functioning Product. The Factory warranty does not cover, without limitation, Consequential Loss, repair reimbursement costs, transport costs, travel costs, accommodation cost of SOFARSOLAR personnel as well as any costs of associated third party staff and personnel. Express delivery costs will not be covered.

In the event SOFARSOLAR, in its sole discretion, decides that any faulty or otherwise defective Product will be repaired on-site or otherwise replaced, in some service areas or business cases, to encourage the End User using the installer's facilities to receive a faultless and functioning product, SOFARSOLAR may, in its sole discretion, offer a rebate to the End User or local installer/electrician to cover the on-site service labour under the following conditions:

The rebate will be eligible ONLY to the party who has carried out on-site service for the purported faulty or otherwise defective Product;

The purported faulty or otherwise defective Product has been returned in the original replacement product packaging to SOFARSOLAR and deemed to have workmanship or material defects upon testing and inspection by SOFARSOLAR. If the purported faulty or otherwise defective Product is deemed free of faults and defects that would qualify a replacement under these Terms and Conditions, then SOFARSOLAR is entitled to charge a retail price of the Product(s), shipping and packaging and any associated labour cost in replacing the purported faulty or otherwise defective Product;

SOFARSOLAR must be contacted prior to the site visit for authorisation. If the site is not located in a metropolitan area in Australia or if the installer is unable to be on-site, the End User must engage their own electrician to carry out and complete the on-site service;

The service rebate must be claimed strictly within two (2) months of the date upon which the on-site service is authorised by SOFARSOLAR.

SOFARSOLAR retains the right to arrange the warranty service for the End User and to use third parties for performing any warranty services. SOFARSOLAR retains full title and ownership of the supplied replacement Product(s) until the purported faulty or otherwise defective Product has been received in accordance with these terms and conditions.

The End User may contact the dealer (SOFARSOLAR authorised dealer or distributor) or installer if the Product is faulty or otherwise defective.

All other purported costs including, but not limited to, compensation from any direct or indirect Loss arising from the faulty or otherwise defective Product or other facilities of the PV system, or loss of electrical power generated during the product downtime are NOT covered by the SOFARSOLAR limited warranty.

Scope of the Warranty

The warranty stipulated in these Terms and Conditions will not apply if SOFARSOLAR, in its sole discretion, decides that any one (1) of the following occurs:

The End user is in default under the General Terms and Conditions of other agreement governing the purchase of the Product, or

Any damage or defect to the Product is caused any one (1) or more of the following situations (the Dealers or Distributors are responsible and authorized by SOFARSOLAR for the following investigation):

Disassembly, attempted repair or modifications performed by any person not authorised by SOFARSOLAR in writing, or serial number or seals have been removed. Product modifications, design changes or part replacements without prior written approval of SOFARSOLAR;

The End user or installer has failed, refused or otherwise neglected to comply with the applicable safety regulations (IE, VDE standards or equivalent) governing the proper use of the Product in force from time to time;

The Product has been improperly stored and damaged by the dealer, distributor or the End User;

The fault or otherwise defect is damage sustained during transportation (including painting scratch caused by movement inside packaging during shipping). A Claim for such transport damage should be made directly to the shipping company/insurance company as soon as the container/packaging is unloaded and such damage is identified;

The Product has been used and installed by an unauthorised or unlicensed installer who fails, refuses, or otherwise neglects to strictly follow any applicable user manual, installation guide and maintenance regulations supplied with the Product, including not ensuring sufficient ventilation for the Product as described in SOFARSOLAR installation guide;

Defects, faults, cosmetics or rendered non-functional damage caused by unforeseen circumstances, or force majeure event including, but not limited to, any vandalism, violent or stormy weather, lightning, flooding, power fluctuation, overvoltage, grid power surge, pests, fire damage, wind damage, or exposure to

erosion, sea coasts/saltwater or other aggressive atmospheres or environmental conditions;

Use of the Product in combination with any unauthorised products, equipment or materials as per the user manual, installation guide and maintenance regulations supplied with the Product;

Combining the Product with any lead acid battery pack or any other lithium battery pack that is not listed on any SOFARSOLAR's battery compatibility list from time to time.

Limitation of Liability

a) This limited warranty supersedes and otherwise replaces any different SOFARSOLAR warranties and liabilities, whether oral, in writing, (non-obligatory) statutory, contractual, in tort or otherwise, consisting of, without quandary, and where permitted by using relevant law, any implied conditions, warranties or different phrases as regards exemplary quality or fitness for purpose. However, this limited warranty shall neither exclude nor limit any of your legal (statutory) rights provided under the relevant national laws and regulations.

b) Subject to clauses 4(c) and (d):

i. all warranties, descriptions, representations, guarantees or conditions, whether express or implied by law, trade, custom or otherwise, and all specific conditions, even though such conditions may be known to SOFARSOLAR, are, to the fullest extent, expressly excluded;

ii. SOFARSOLAR is not liable for any delay or Loss arising from the supply of or failure to supply the Product or comply with an order of the End User whether due to shortfall, defect, incorrect delivery or otherwise for any reason whatsoever including breach of contract (including fundamental breach), negligence, breach of duty as bailee, or the wilful act or default of SOFARSOLAR.

c) These Terms and Conditions shall not exclude or limit the application of any provisions of any statute including any implied condition or warranty the exclusion of which would contravene any statute (including the ACL) or cause any part of this clause 4 to be illegal, invalid, void or unenforceable.

d) If the exclusion of liability in clause 4(b) is reduced, void or not available, SOFARSOLAR's liability for any Claims arising out of these Terms and Conditions, including liability for breach of these Terms and Conditions, in negligence or in tort or for any other common law or statutory action, shall:

i. be limited to the extent the Loss the subject of the Claim was caused directly by SOFARSOLAR; and

ii. in all events, exclude Loss relating to any delay in supply of the Product and for any Consequential Loss.

e) SOFARSOLAR guarantees the performance of the Product under the normal working conditions within the standard warranty term and provide limited technical support if applicable. However, SOFARSOLAR shall assume no liability for system malfunctions and any incurred loss or damages whatsoever.

Please refer to SOFARSOLAR Energy Storage Warranty Terms and Conditions for further information on SOFARSOLAR Energy Storage products.

Procedure for Claiming a Warranty

In the case of a faulty or otherwise defective Product please report that Product within the agreed warranty period, with a detailed error description to SOFARSOLAR's service hotline for registering and send the claim to SOFARSOLAR service department by fax/email or through SOFARSOLAR Warranty Claim Website at <https://service.sofarsolar.com/warranty/search> to process the warranty claim. The End User may also contact the dealer (SOFARSOLAR authorised dealer or distributor) or installer if the Product is defective or faulty.

To make a claim under the warranty, the End User must provide the following information and documentation of the faulty or otherwise defective Product:

Product Model and serial number

A copy of the valid purchasing invoice

Fault descriptions and error IDs (where applicable)

End user and/or claimant details

Detailed information about the entire system (module, PV system diagram, installation date, etc.)

Documentation of previous claims/exchanges (if applicable)

The warranty may not be guaranteed if the above information is not provided.

Extension of the Warranty Period

For SOFARSOLAR inverters, the End User may apply for a Warranty Period extension within 24 months for grid-tied inverter <50kW and 12 months for grid-tied ≥ 50 kW and energy storage inverter(hybrid) inverters from the date of production from SOFARSOLAR by providing the serial number and copy of the warranty card of the Product. SOFARSOLAR may reject any application received which does not meet the date requirement. An extended Warranty Period can be purchased to 10, 15, or 20 years. Please refer to the Warranty Extension Order Form for more information.

Once the purchase of the Warranty Period extension has been processed, SOFARSOLAR will send a Warranty Period extension certificate to the End User confirming the extended Warranty Period.

Any faults or defects that occur after the expiry of the Warranty Period, or which occur within the Warranty Period but which are listed in the warranty exceptions above, are deemed to be out-of-warranty cases. For all out-of-warranty cases,

SOFARSOLAR, in its sole discretion, may charge fees to the End User including, without limitation:

- a) On-site service fee: cost of travel and time for the technician to deliver on-site service and labour cost for the technician, who is repairing, performing maintenance on, installing (hardware or software) and debugging the faulty product.
- b) Parts/materials fee: cost of replacement parts/materials (including any shipping/admin fee that may apply).
- c) Logistics fee: cost of delivery and any other expenses incurred when defective products are sent from the user to SOFARSOLAR or/and repaired products are sent from SOFARSOLAR to the user.

Latest information about the warranty terms and conditions and local service hotline can be obtained from our website: www.sofarsolar.com.au

Contact us

You can directly contact our professional after-sales team:

Sofarsolar Ausco Pty Ltd.

Tel: +61 401 734 463 / 408 500 386

Shenzhen Sofarsolar Co., Ltd.



Product Name: PV Grid-Connected Inverter
Company Name: Shenzhen SOFARSOLAR Co., Ltd.
ADD: 401, Building 4, AnTongDa Industrial Park, District 68, XingDong Community,
XinAn Street, BaoAn District, Shenzhen, Guangdong.P.R. China
Email: service@sofarsolar.com
Tel: 0510-6690 2300
Web: www.sofarsolar.com



301.00000284-0